



Cal. 2706A

### Characteristics

Casing diameter: 17.20  $\phi$  mm  
 Maximum height: 5.70 mm  
 Vibrations per hour: 28,800  
 Automatic and auxiliary hand winding with sweep second  
 Calendar (day & date)  
 Instant setting device for day & date calendar  
 Bilingual change-over system for day of week  
 "Diashock" Shock Resistant Device



112581



122581



161581



171581



205581



213581



224581



225581



231581



241581



245581



251581



301581



310581



315581



331581



341581



345581



261581



271581



282581



283581



284581



285581



287581



381581



383581



384581



385581



387581



388581



396581



397581



401581



481581



765581



766581



775581



354581



014433



014434



014435



011212



014417



189581



500581



821581



823581



831581



837581



838581



☆801581



802581



803581



806581



808581



810581



812581



817581



868581



☆873581



873581



☆884581



☆884582



963581



980581



022177



022281



022282



022276



022481



022484



022490



022491



022492



022570



022688



022753



022764



390581

$\frac{2}{1}$

Catalog No.

Calibre No.		Jewels	Style Name	
<b>2706A</b>		<b>21j</b>		
PART NO.	LIST OF MATERIALS	PART NO.	LIST OF MATERIALS	
112581	Barrel & train-wheel bridge	810581	Date jumper	
122581	Center wheel bridge	812581	Setting wheel lever spring	
161581	Pallet cock	817581	Intermediate date wheel	
171581	Balance cock	868581	Day finger	
189581	Transmission wheel bridge with wheel	☆870583	Day star with dial disk (English ↔ Spanish)	
205581	Complete barrel with arbor	873581	Day jumper	
213581	Barrel arbor	☆884581	Holding ring for dial	
224581	Center wheel & pinion with cannon pinion	☆884582		
225581	Cannon pinion	963581	Snap for day star with dial disk	
231581	Third wheel & pinion	980581	First intermediate wheel for day-date correction	
241581	Fourth wheel & pinion	980581	Second intermediate wheel for day-date correction	
245581	Sweep second pinion	022177	Stud screw	
251581	Escape wheel & pinion	022281	Center wheel bridge screw	
261581	Minute wheel	022281	Setting lever spring screw	
271581	Hour wheel	022282	Pallet cock screw	
282581	Clutch wheel	022276	Minute wheel bridge screw	
283581	Winding pinion	022276	Transmission wheel bridge screw	
284581	Crown wheel	022481	Bridge screw	
285581	Ratchet wheel	022484	Setting wheel lever spring screw	
287581	Intermediate ratchet wheel	022490	Screw for oscillating weight	
301581	Jewelled pallet fork & staff	022491	Screw for ball-bearing complete	
310581	Balance complete with stud	022492	Friction spring screw for sweep second pinion	
315581	Balance staff	022570	Crown wheel screw	
331581	Roller with jewel	022688	Date driving wheel screw	
341581	Regulator	022753	Date dial guard screw	
345581	Stud holder	022753	Day jumper screw	
354581	Winding stem	022764	Dial screw	
381581	Click	011716	Upper hole jewel for center wheel	
383581	Setting lever	011153	Lower hole jewel for center wheel	
384581	Yoke (Clutch lever)	011404	Upper hole jewel for 3rd wheel	
385581	Yoke spring (Clutch lever spring)	011308	Lower hole jewel for 3rd wheel	
387581	Minute wheel bridge with day corrector wheel	011505	Upper hole jewel for 4th wheel	
388581	Setting lever spring	011505	Lower hole jewel for 4th wheel	
390581	Setting lever axle	011404	Upper hole jewel for sweep second pinion	
396581	Friction spring for sweep second pinion	011522	Upper hole jewel for escape wheel	
397581	Lever for unlocking stem	011522	Lower hole jewel for escape wheel	
401581	Mainspring with slipping attachment	011522	Upper hole jewel for pallet	
481581	Crown wheel ring	011522	Lower hole jewel for pallet	
765581	Intermediate setting lever	011151	Lower hole jewel for transmission wheel	
766581	Intermediate minute wheel	023148	Tube for pallet cock screw	
775581	Intermediate ratchet wheel spring	023188	Tube for screw of ball-bearing complete	
014433	Diashock upper frame	023191	Tube for transmission wheel bridge screw	
014434	Diashock lower frame	023472	Intermediate setting lever pin	
014435	Diashock hole jewel with frame	023475	Pawl lever holder pin	
011212	Diashock cap jewel	023851	Date jumper pin	
014417	Diashock spring			
500581	Oscillating weight			
821581	Ball-bearing complete with pawl lever holder			
823581	Eccentric post			
831581	Pawl lever with jewel			
837581	Pawl lever holder			
838581	Pawl lever seat			
☆801581	Date dial			
802581	Date driving wheel			
803581	Setting wheel lever complete			
806581	Date corrector wheel			
808581	Date dial guard			

☆ ⇨ Please see remarks on the next page.  
 Items in light letters are not shown in photos.

☆ ⇨ Please see remarks on the next page.

Calibre No. <b>2706A</b>	Jewels <b>21j</b>	Style Name
-----------------------------	----------------------	------------

**Remarks:**

**Date dial**

☆ 801581 (Black figures on white background) ..... Used when both the crown and the date frame are located at **3** o'clock.

If the date dial is required in any other type, specify ① Cal. No. ② the crown position ③ the date frame position and ④ the dial No.

**Day star with dial disk**

☆ 870583 (English ↔ Spanish) ..... Used when both the crown and the day frame are located at **3** o'clock.

When ordering any other type of the day star with dial disks, clearly mention the number printed on the disk. If the number is unknown, specify ① Cal. No. ② the crown position ③ the day frame position ④ the dial No. and ⑤ the national language.

**Holding ring for dial**

The holding ring for dial comes in different shapes for specific dial models. Select the suitable one by referring to the photos in the front page and the sectional shapes in the following diagram. If the part number of the holding ring for dial is unknown or its shape is different from those in the diagram, specify ① Cal. No. ② the dial No. and ③ the case No. when ordering.

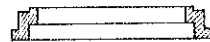

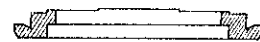

☆ 884581



☆ 884582

# SEIKO

Calibre No. <b>2706A</b>	Jewels <b>17j</b>	Style Name
⇒ Basic Calibre 2706A 21J Catalog No. 27-06-1		
 <p>Cal. 2706A</p>		<b>Characteristics</b> Casing diameter : 17.20 <sup>φ</sup> mm Maximum height : 5.70 mm Vibrations per hour : 28,800 Automatic and auxiliary hand winding with sweep second Calendar (day & date) Instant setting device for day & date calendar Bilingual change-over system for day of week "Diashock" Shock Resistant Device
 <p>112582      171582      500582</p>		

Catalog No. 27-06-2

Calibre No. <b>2706A</b>	Jewels <b>17j</b>	Style Name	
⇒ Basic Calibre 2706A 21J Catalog No. 27-06-1			
PART NO.	LIST OF MATERIALS	PART NO.	LIST OF MATERIALS
112582	<b>Barrel &amp; train-wheel bridge</b>	868581	Day finger
122581	Center wheel bridge	☆870583	Day star with dial disk (English ↔ Spanish)
161581	Pallet cock	873581	Day jumper
171582	<b>Balance cock</b>	☆884581	Holding ring for dial
189581	Transmission wheel bridge with wheel	☆884582	
205581	Complete barrel with arbor	963581	Snap for day star with dial disk
213581	Barrel arbor	980581	First intermediate wheel for day-date correction
224581	Center wheel & pinion with cannon pinion		Second intermediate wheel for day-date correction
225581	Cannon pinion	980581	Stud screw
231581	Third wheel & pinion	022177	Minute wheel bridge screw
241581	Fourth wheel & pinion	022276	Transmission wheel bridge screw
245581	Sweep second pinion	022276	Center wheel bridge screw
251581	Escape wheel & pinion	022281	Setting lever spring screw
261581	Minute wheel	022281	Pallet cock screw
271581	Hour wheel	022282	Bridge screw
282581	Clutch wheel	022481	Setting wheel lever spring screw
283581	Winding pinion	022484	Screw for oscillating weight
284581	Crown wheel	022490	Screw for ball-bearing complete
285581	Ratchet wheel	022491	Friction spring screw for sweep second pinion
287581	Intermediate ratchet wheel	022492	Crown wheel screw
301581	Jewelled pallet fork & staff	022570	Date driving wheel screw
310581	Balance complete with stud	022688	Date dial guard screw
315581	Balance staff	022753	Day jumper screw
331581	Roller with jewel	022753	Dial screw
341581	Regulator	022764	Upper hole jewel for center wheel
345581	Stud holder	011716	Lower hole jewel for center wheel
354581	Winding stem	011153	Lower hole jewel for 3rd wheel
381581	Click	011308	Upper hole jewel for escape wheel
383581	Setting lever	011522	Lower hole jewel for escape wheel
384581	Yoke (Clutch lever)	011522	Upper hole jewel for pallet
385581	Yoke spring (Clutch lever spring)	011522	Lower hole jewel for pallet
387581	Minute wheel bridge with day corrector wheel	01151	Lower hole jewel for transmission wheel
		023148	Tube for pallet cock screw
388581	Setting lever spring	023188	Tube for screw of ball-bearing complete
390581	Setting lever axle	023191	Tube for transmission wheel bridge screw
396581	Friction spring for sweep second pinion	023472	Intermediate setting lever pin
397581	Lever for unlocking stem	023475	Pawl lever holder pin
401581	Mainspring with slipping attachment	023851	Date jumper pin
481581	Crown wheel ring		
765581	Intermediate setting lever		
766581	Intermediate minute wheel		
775581	Intermediate ratchet wheel spring		
014433	Diashock upper frame		
014434	Diashock lower frame		
014435	Diashock hole jewel with frame		
011212	Diashock cap jewel		
014417	Diashock spring		
500582	<b>Oscillating weight</b>		
821581	Ball-bearing complete with pawl lever holder		
823581	Eccentric post		
831581	Pawl lever with jewel		
837581	Pawl lever holder		
838581	Pawl lever seat		
☆801581	Date dial		
802581	Date driving wheel		
803581	Setting wheel lever complete		
806581	Date corrector wheel		
808581	Date dial guard		
810581	Date jumper		
812581	Setting wheel lever spring		
817581	Intermediate date wheel		

☆⇒ Please see remarks on the next page.

Items in light letters are not shown in photos; those parts are interchangeable with the basic calibre

(Cal. No. 2706A 21J Catalog No. 27-06-1 Red page).

As for all other parts not shown here, please refer to the basic calibre

(Cal. No. 2706A 21J Catalog No. 27-06-1 Red page).

Calibre No. <b>2706A</b>	Jewels <b>17j</b>	Style Name
↔ Basic Calibre 2706A 21J Catalog No. 27-06-1		

**Remarks:**

**Date dial**

☆801581 (Black figures on white background) ..... Used when both the crown and the date frame are located at 3 o'clock.

If the date dial is required in any other type, specify ① Cal. No. ② the crown position ③ the date frame position and ④ the dial No.

**Day star with dial disk**

☆870583 (English ↔ Spanish) ..... Used when both the crown and the day frame are located at 3 o'clock.

When ordering any other type of the day star with dial disks, clearly mention the number printed on the disk. If the number is unknown, specify ① Cal. No. ② the crown position ③ the day frame position ④ the dial No. and ⑤ the national language.

**Holding ring for dial**

The holding ring for dial comes in different shapes for specific dial models. Select the suitable one by referring to the photos in the page of the basic calibre (Catalog No.27-06-1) and the sectional shapes in the following diagram.

If the part number of the holding ring for dial is unknown or its shape is different from those in the diagram, specify ① Cal. No. ② the dial No. and ③ the case No. when ordering.

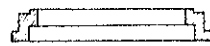

☆884581

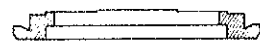

☆884582

# 2706A

## 2706A Calendar Mechanism

### 1) Specifications:

Casing diameter 17.20mm  
 Height 5.70mm  
 Vibrations per hour 28,800  
 Automatic winding (with hand winding mechanism)  
 Calendar (day and date; bilingual change-over mechanism for day indication, instant day and date setting device)

### 2) Features:

This is a lady's wrist watch with a variety of functions. Up to now, it was considered difficult to provide a lady's wrist watch with various functions due to its small size. However, calibre 2706 has proved this concept to be erroneous.

### Stabilized movement:

A lever system is adopted for the automatic winding mechanism. Precision is sufficiently stabilized by a high beat (8 beat); further, auxiliary hand winding mechanism is provided.

### Easy-to-use day and date correction:

Day-date correction is simply operated by turning a crown to the right or left after pulling out the crown to the second click. And at the same time, either one of the two languages provided can be chosen to indicate the day of the week.

### Easy-to-see calendar:

Letters indicating the day and date are large enough to ensure quick, easy reading.

### 3) Disassembly and assembly:

Disassemble the watch in the order of Figs. ①—⑦⑩

Assemble by reversing the above order: Figs. ⑦⑩—①

### 4) Lubrication:

Colored symbols in the illustrated figures indicate the types of oil, the quantity to be applied, and the lubricating points.

### Types of oil:

- ▶ Moebius Synt-A-Lube
- ▶ Seiko watch oil S-4
- ▶ Seiko watch oil S-3

### Oil quantity:

- ▶ Extremely small quantity
- ▶▶ Normal quantity
- ▶▶▶ Sufficient quantity

As lubricating points other than portions marked with the above symbols are separately indicated, lubricate correctly.

- ⊗ Oil must not be applied.

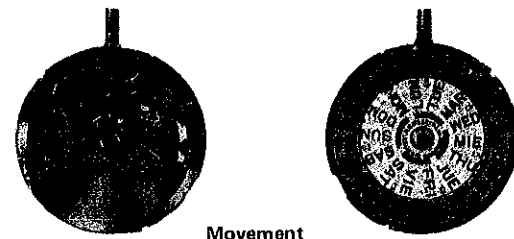

Movement

### An example of casing construction

There is a model whose construction has the following glass portion.

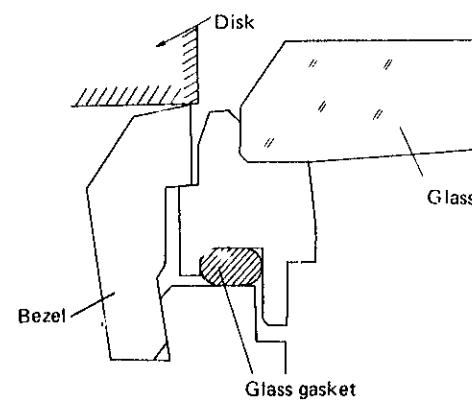

### Precautions when assembling

- (1) Insert a gasket into the gasket groove and set the bezel; then push the bezel in.
- (2) Use a disk which does not contact the glass ring when pushing in the bezel by the disk.
- (3) Set the pry opening port on the bezel to its original position.
- (4) It is unnecessary to apply silicone grease to the glass gasket.

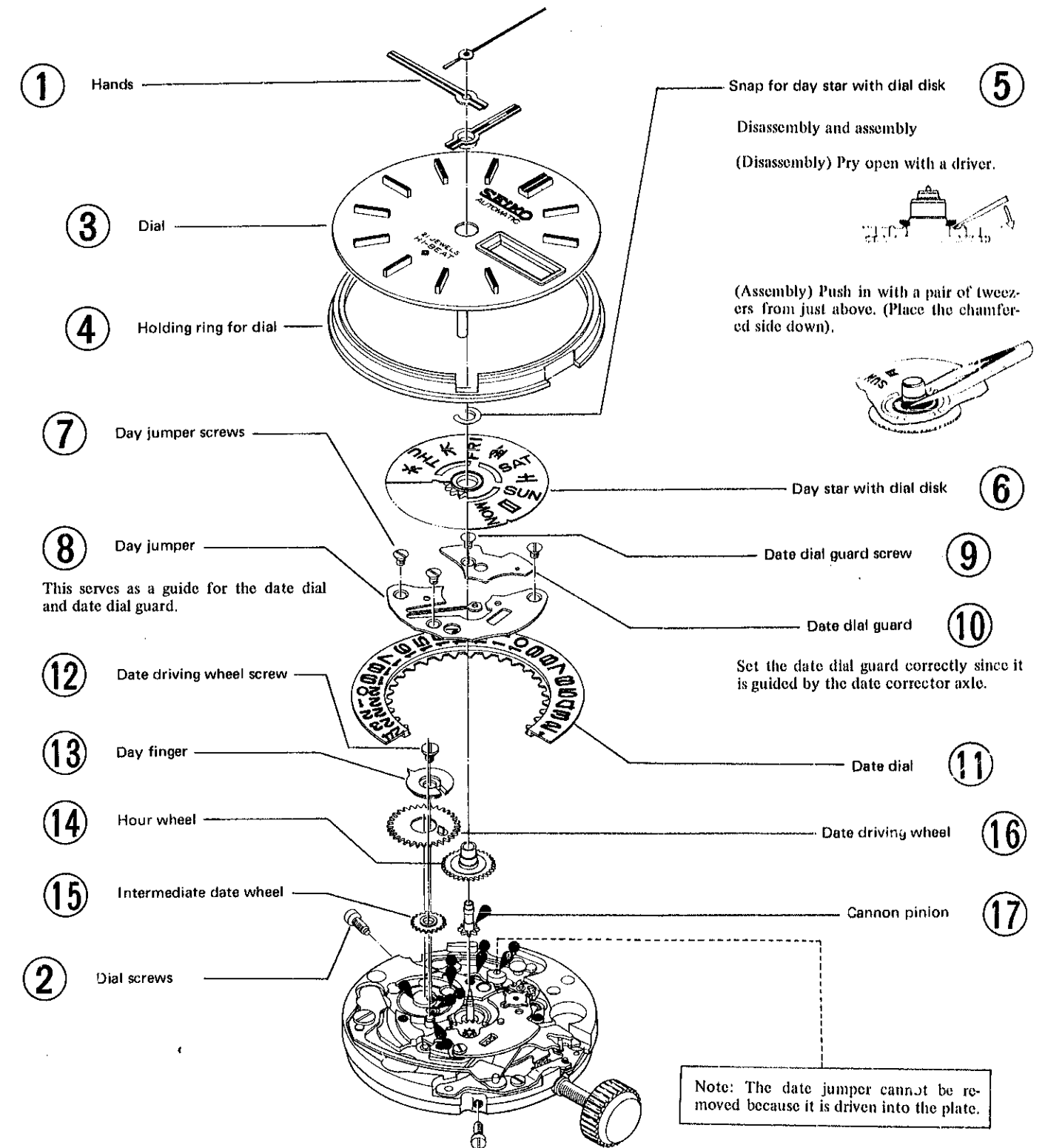

Note: The day and date setting device and bilingual change-over mechanism for day indication will not operate from 8:30 P.M. to 3:30 A.M. since this period is used for day and date driving time.

# 2706A Automatic Winding, Escapement and Governor Mechanism

# 2706A Train Wheel

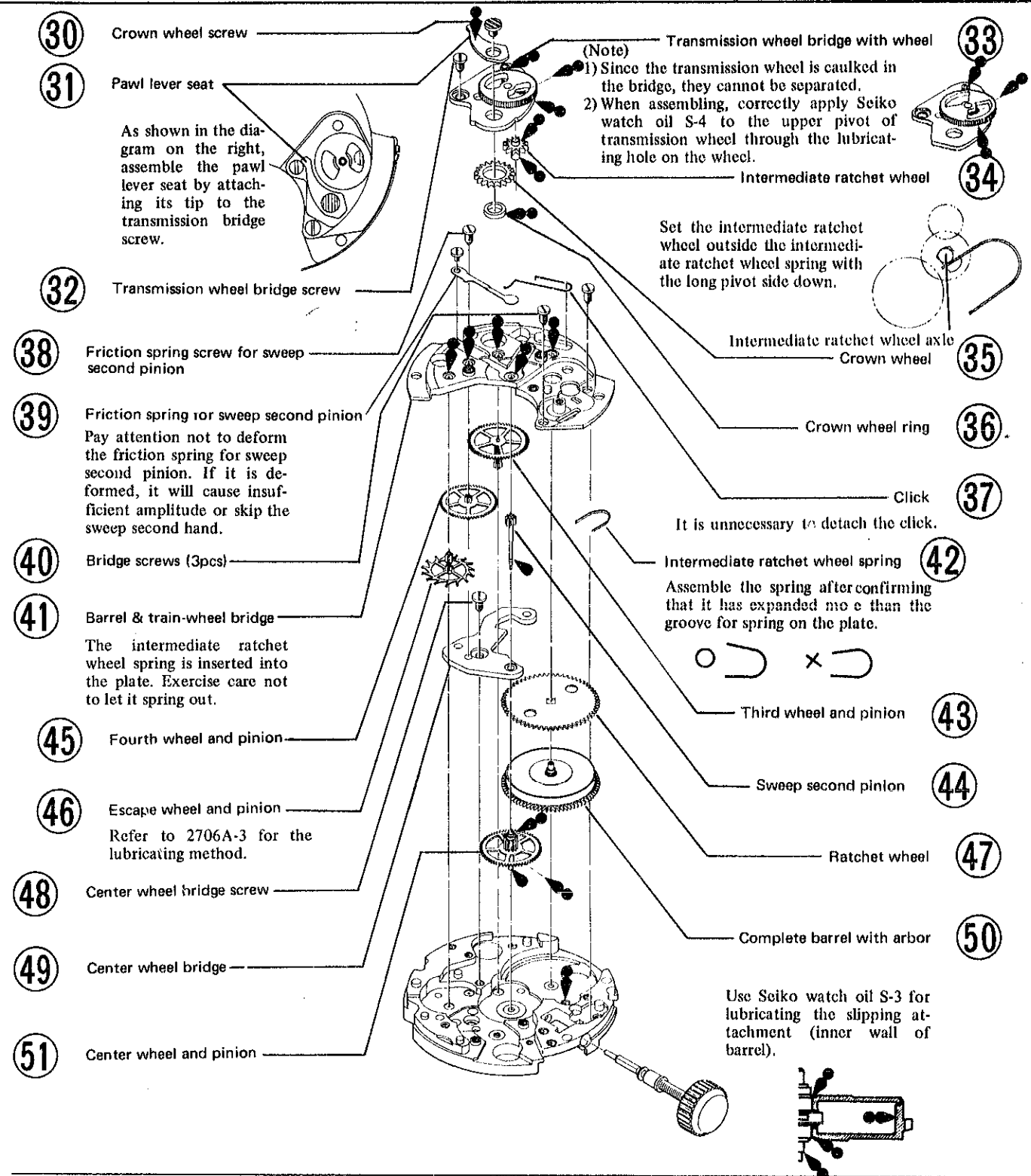
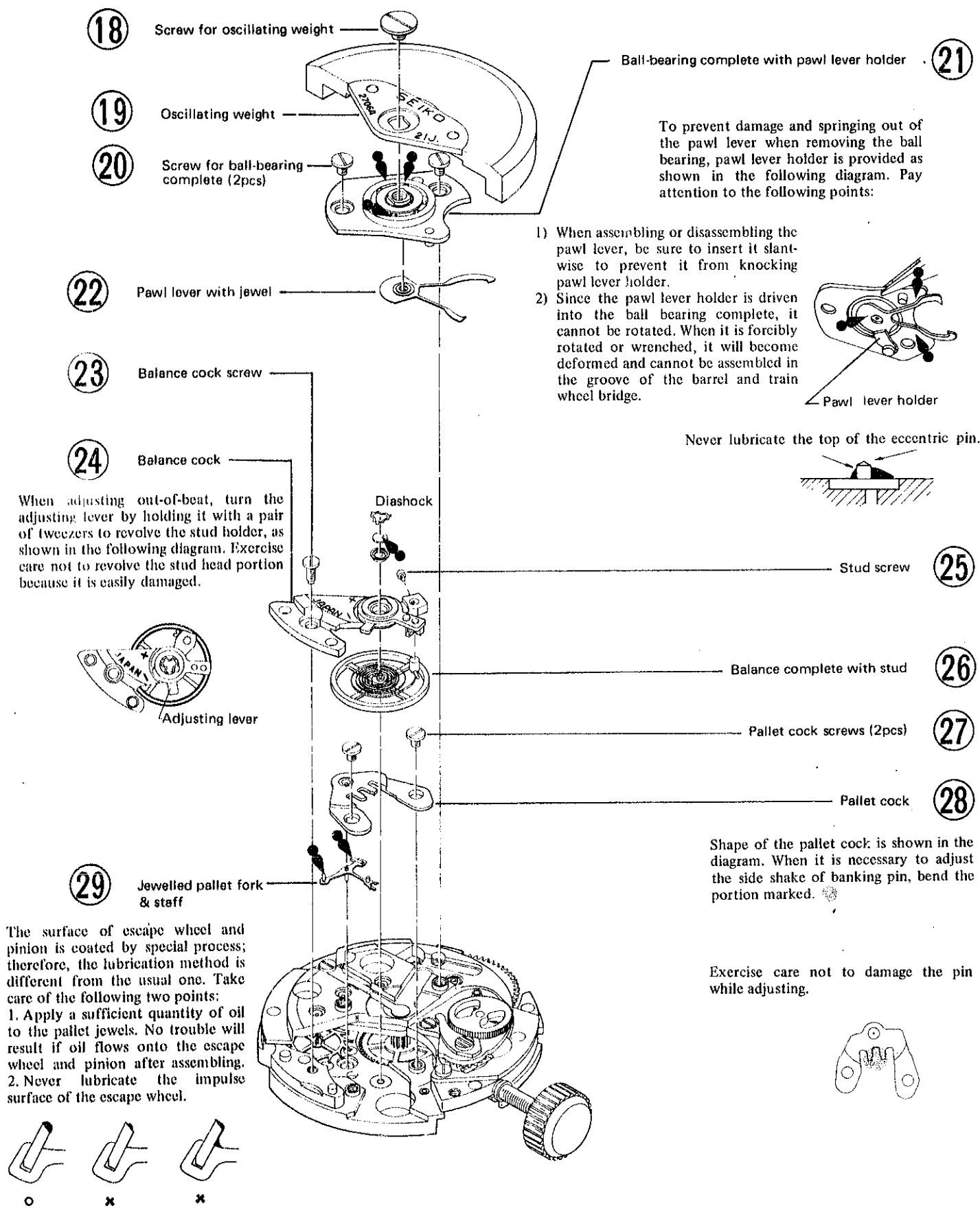

### Hand winding mechanism

When turning the crown in its ordinary position, the mainspring is wound by interlocking the intermediate ratchet wheel and the transmission wheel pinion.

When the automatic winding mechanism is operating, the intermediate ratchet wheel detaches from the transmission wheel pinion; thus, the hand winding train wheel does not obstruct winding capability of the automatic winding mechanism.

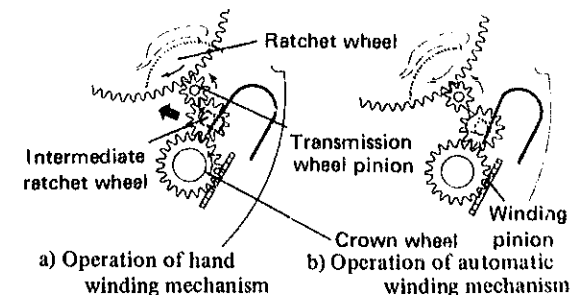

## 2706A Setting Mechanism

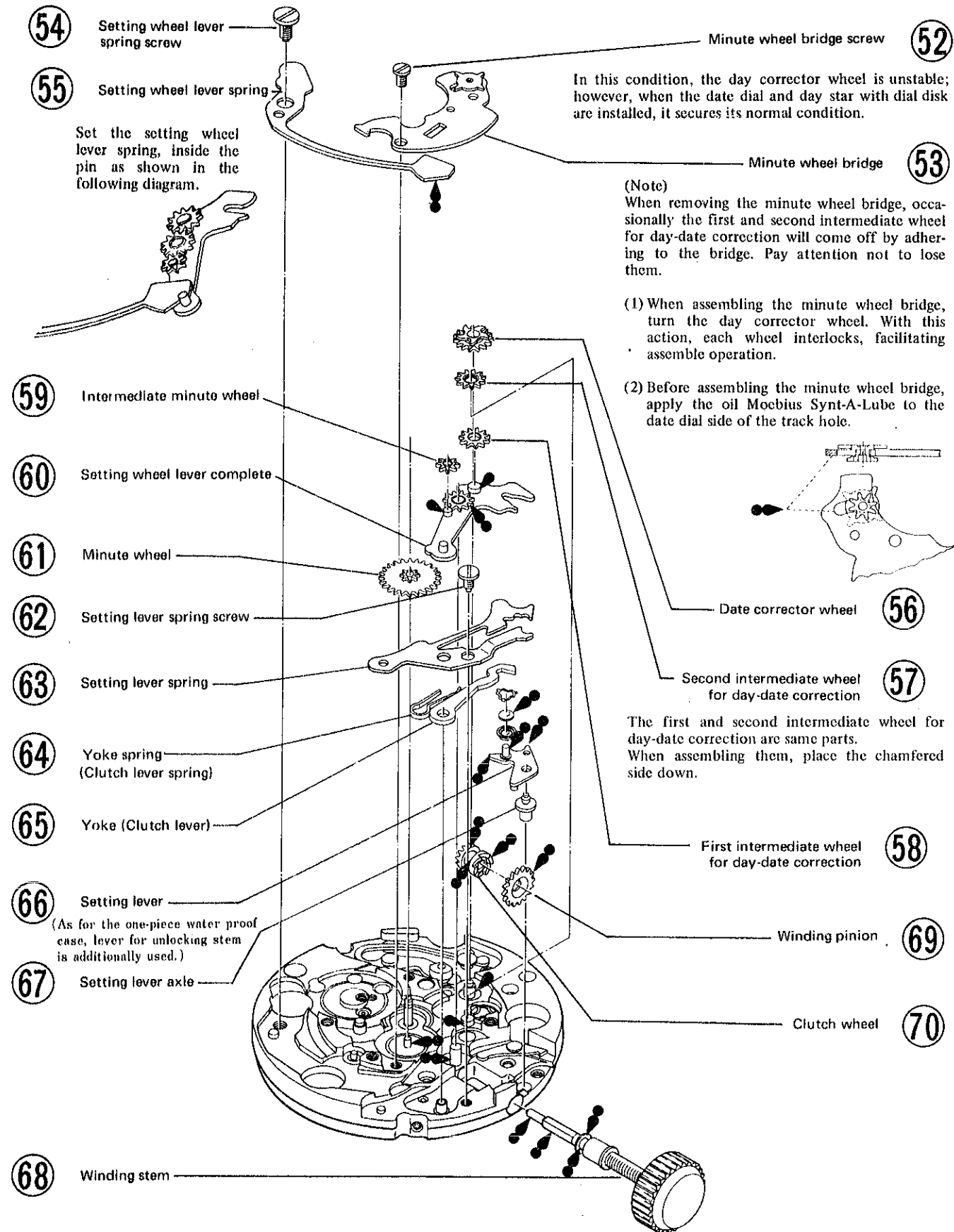

## 2706A Setting Mechanism

### Crown ordinary position (mainspring winding)

The mainspring can be wound by turning the crown at the position where the winding pinion and clutch wheel interlock.

Fig. 1

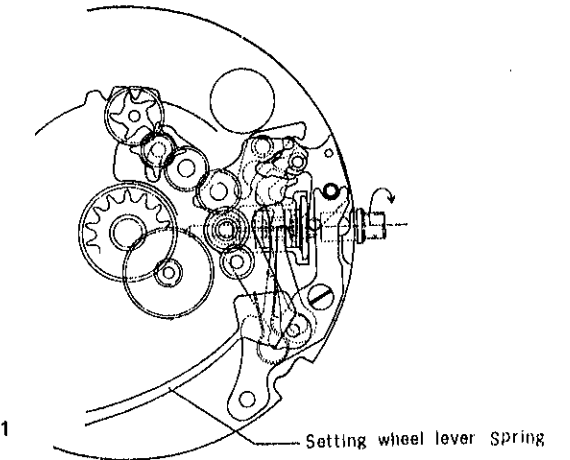

Fig. 1

### Position where the crown is pulled out to the second click (setting day and date)

In the condition where the clutch wheel and setting wheel (located under the setting transmission wheel, it rotates together with setting transmission wheel) interlock, when the crown is turned clockwise the day star with dial disk is quickly forwarded. By turning in reverse (counter-clockwise), the date dial is quickly forwarded.

Fig. 2

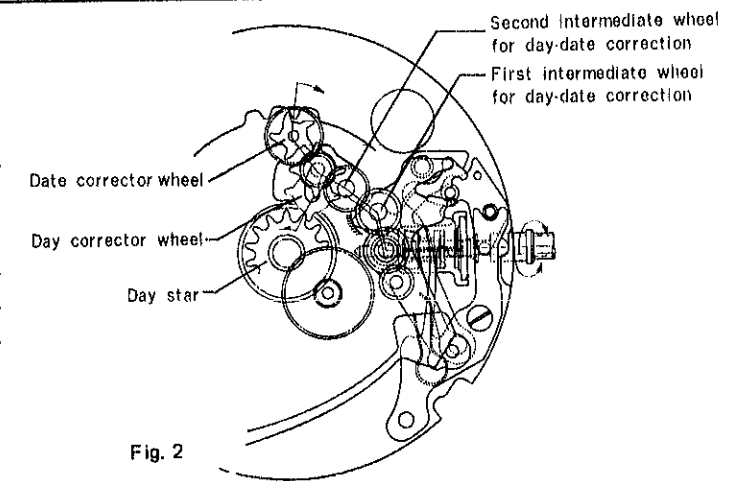

Fig. 2

### Position where the crown is pulled out to the third click (setting time)

The intermediate minute wheel interlocks with the minute wheel as a result of the setting wheel lever complete being pushed by the setting lever. When the crown is turned at this position, the hands can be set.

Fig. 3

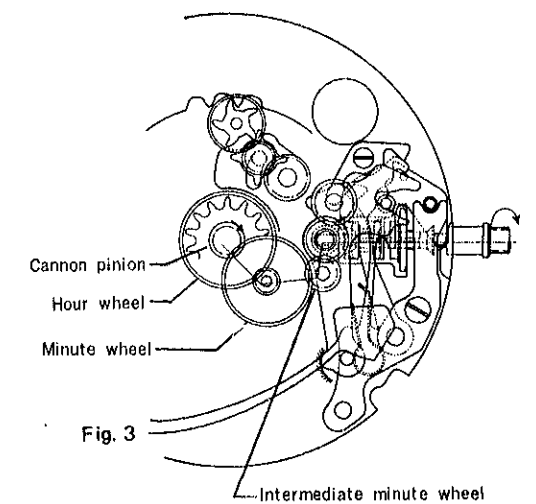
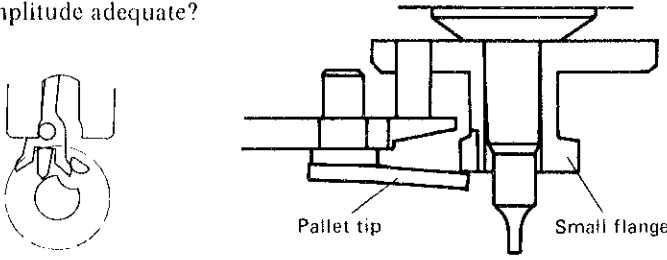
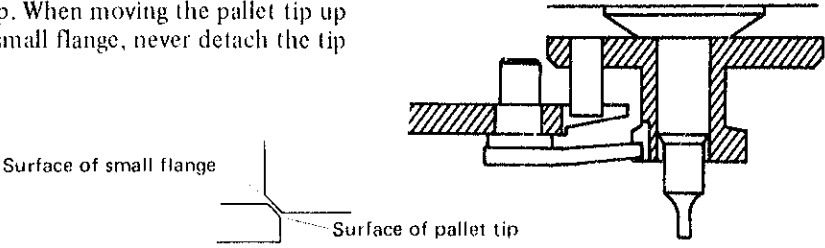
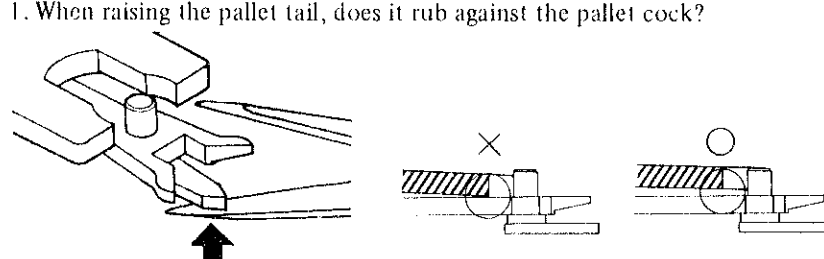
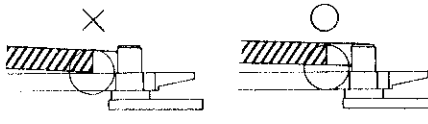
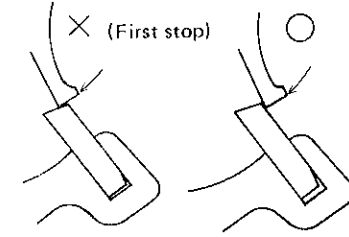
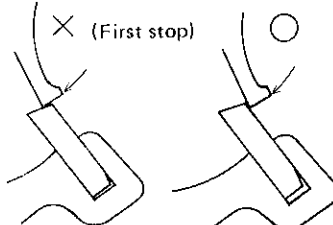
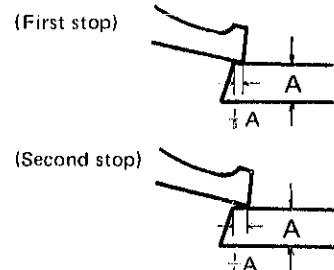
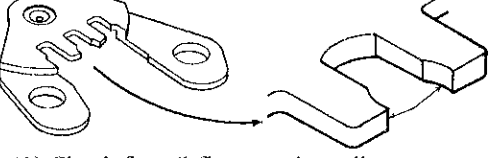
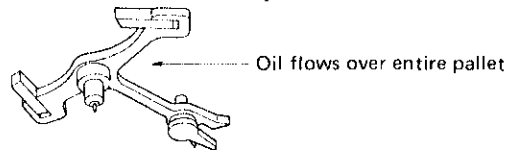
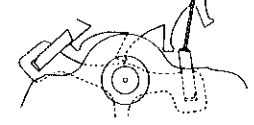
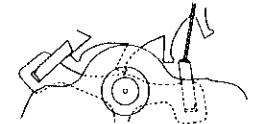
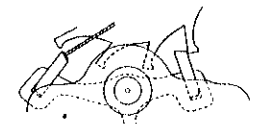
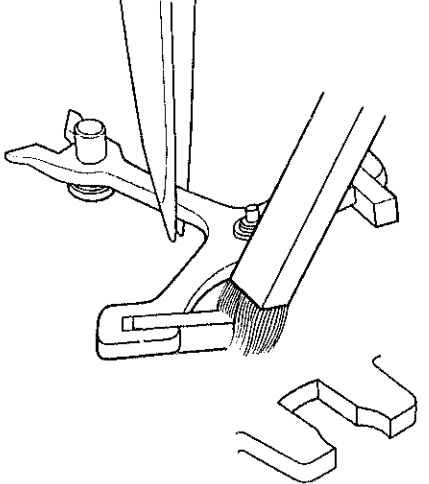

Fig. 3

# 2706A CHECKING AND REPAIRING-1

Phenomena	Items to be checked	Repairing Method
<p>1. Watch stops although main-spring is fully wound.</p>	<p>1. Is the amplitude adequate?</p> 	<p>Adjust height of the pallet tip. When moving the pallet tip up and down in examining it and small flange, never detach the tip and small flange.</p> 
<p>2. Watch occasionally stops. Watch loses considerably.</p>	<p>1. When raising the pallet tail, does it rub against the pallet cock?</p>  	<p>Adjust hole jewel position of the pallet cock.</p>  <p>Standardize surface of the pallet cock</p> <p>Always check shakes of the pallet after adjustment.</p>
	<p>2. Any slip on the jewel meshing?</p> <p>(1) With the first stopping does the meshing directly drop on the impact surface?</p> <p>(2) Check each tooth of the escape wheel</p> 	<p>Adjust meshing amount of the jewel. When adjusting one side, always confirm meshing amount of both sides.</p> 
<p>3. Is there any oil flow or dirt on the escapement?</p> <p>(1) Check for dirt on banking portion of the pallet cock and tip of the pallet</p> <p>(2) Check for oil flow on the pallet</p> <p>(3) Check for dirt on roller jewel of the balance</p>	  	<p>* Wash the pallet and pallet cock. After washing pallet finger tip, pin portion of pallet tip, and banking portion of pallet cock with a brush, rinse them in benzine. Dry them thoroughly.</p> <p>* After washing and assembling pallet and pallet cock, lubricate the jewel by using an oiling bar or glass oiling injector.</p>    <p>Lubrication of Entry pallet jewel      Lubrication of Exit pallet jewel</p> <p>* Washing of the balance Wipe the roller jewel well, then rinse it in benzine. Dry it well. (When washing, remove the shock resistant hole jewel with frame).</p>





## 2706A CHECKING AND REPAIRING

When a customer requests that a watch be repaired, the first prerequisite is to inquire on the exact nature of the malfunction.

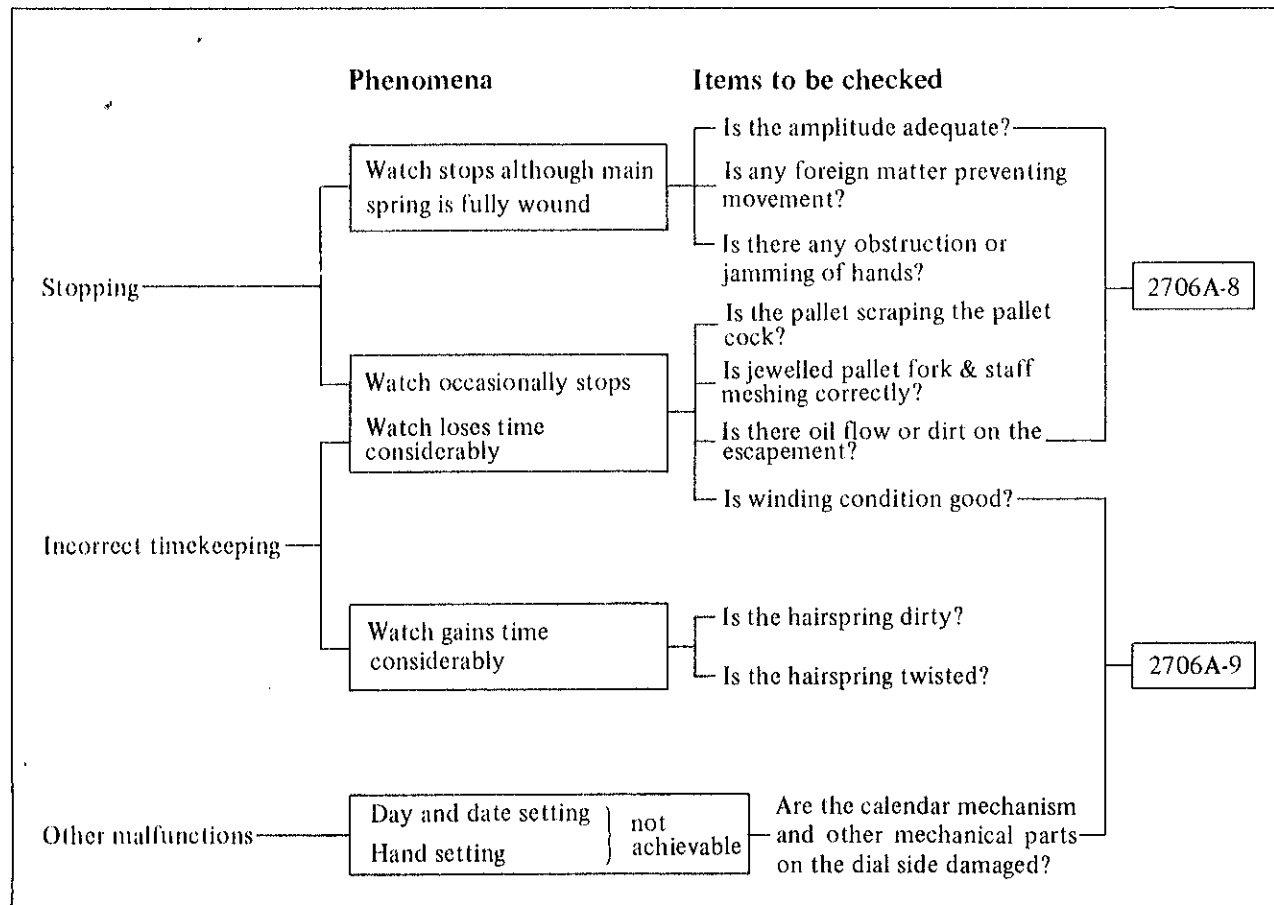
With the information obtained from the customer, check thoroughly (making repairs where necessary) the following points:

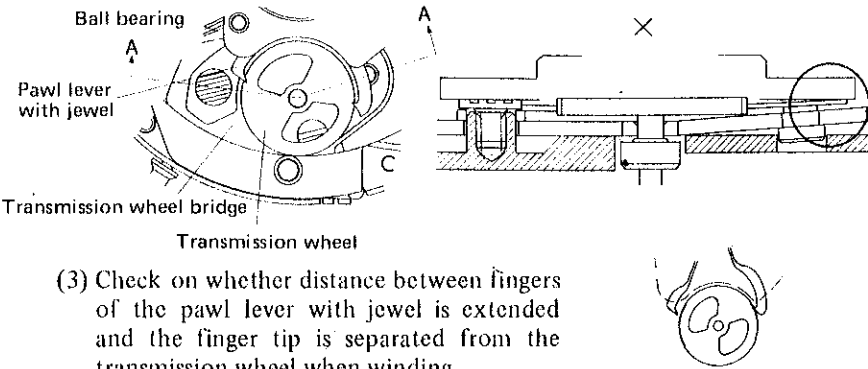

# 2706A CHECKING AND REPAIRING-2

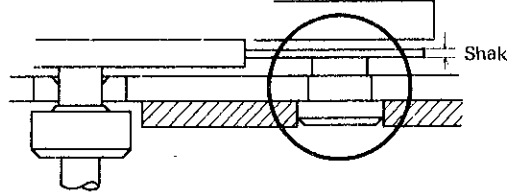
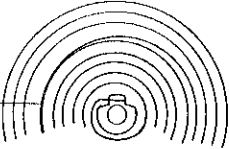
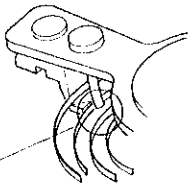
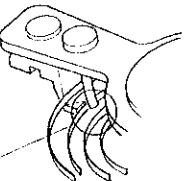
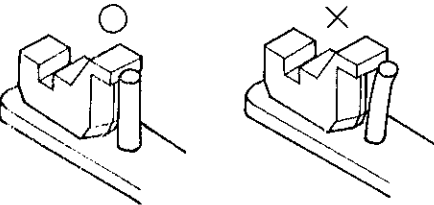
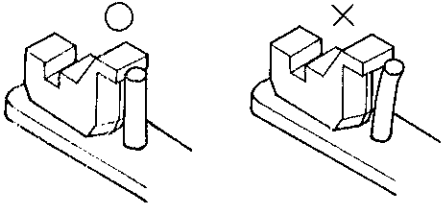
Phenomena	Items to be checked	Repairing Method
	<p>4. Is winding condition of the oscillating weight good? The condition is good when the transmission wheel turns round once within 30 revolutions of the oscillating weight. When the winding condition is defective . . .</p> <p>(1) Check on whether the pawl lever with jewel is bent upward or downward. If bent, winding efficiency is lowered as it scratches the transmission wheel bridge.</p> <p>(2) Check on whether the shake of fingers are reduced by a raised transmission wheel bridge.</p>  <p>(3) Check on whether distance between fingers of the pawl lever with jewel is extended and the finger tip is separated from the transmission wheel when winding.</p>	<p>(1) Correct warp of the pawl lever with jewel</p> <p>(2) Correctly reassemble the transmission wheel bridge</p>  <p>(3) Correct distance between fingers. A = Within double the finger thickness. Adjust with care that distance does not become too narrow.</p> 
3. Watch gains considerably	<p>1. Any dirty portion on the hairspring?</p> <p>Any portion stuck together due to dirt?</p>  <p>2. Is the hairspring twisted? Is the hairspring locked between the regulator key and the stud?</p>  <p>Locked hairspring</p>	<p>Wash the balance.</p> <p>Rinse the balance in fresh benzine and dry it well to prevent the balance coils from touching each other. (When washing, remove shock resistant hole jewel with frame). Refer to next page for details.</p>  <p>After removing the hair spring from twisting, correct bend of the hairspring stud. After correcting, check shape of the hairspring.</p> 
4. Day and date correction Hand setting do not achievable	<p>1. Are the calendar mechanism and other mechanical parts on the dial side damaged? Cracks and loosened setting wheel, first and second intermediate wheel for day-date correction; broken and detached date pin; and broken teeth of clutch wheel.</p> 	<p>Replace parts.</p> <p>Day and date change starts from about 8:30 P.M. and finishes about 3:30 A.M. When day and date are corrected within this period, the correcting device will not function; also, it may be damaged, so never correct the day and date during this period. Explain clearly to the customer that he should never do the correcting during this period.</p>

## 2706A CHECKING AND REPAIRING-3

### 1. Washing and Lubricating Method for Pallet, Pallet Cock, and Balance

#### (1) Washing method for pallet and pallet cock

##### 1. Rough washing

Since the pallet has been subjected to a nondiffusion treatment at the factory, ultrasonic washing should be limited to within one minute. When using a brush for washing, only wash the pallet finger tip, pin portion of the pallet tip, and banking portion of the pallet cock.

##### 2. Rinsing and drying

Rinse the pallet and the pallet cock in fresh benzene, and dry them well by using a dryer or other means. Drying temperature should be less than 40°C.

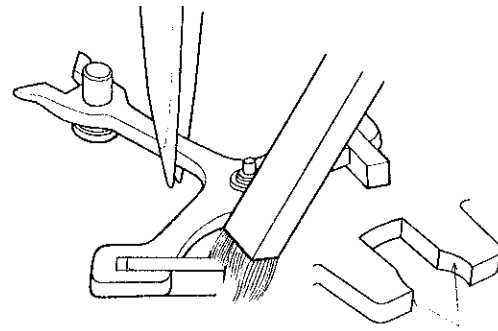

#### (2) Lubricating jewel

When lubricating the pallet jewel, do so after assembling the pallet and the pallet cock. Using a glass oiling injector or oiling bar, sufficiently lubricate the entry pallet jewel and the exit pallet jewel after allowing the tooth tip of the escape wheel to escape. No problem exists when oil is diffused on the escape wheel.

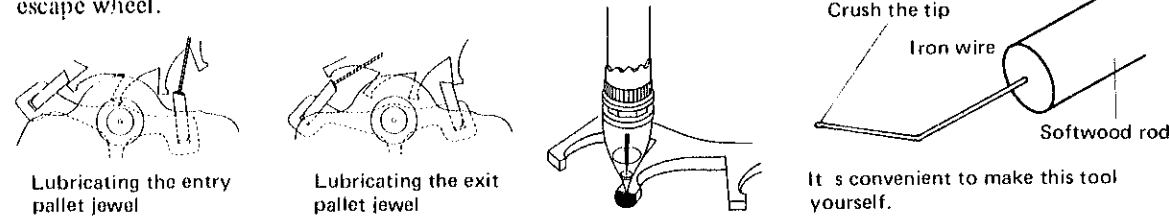

Note: Since the oil quantity cannot be controlled never lubricate the escape wheel directly. (due to special treatment of surface)

#### (3) Washing the balance

##### 1. Rough washing

(The balance can be washed with the balance cock attached; however, remove the shock resistant hole jewel with frame.) Perform ultrasonic washing for one minute. When wiping the balance, wipe and wash the roller jewel thoroughly.

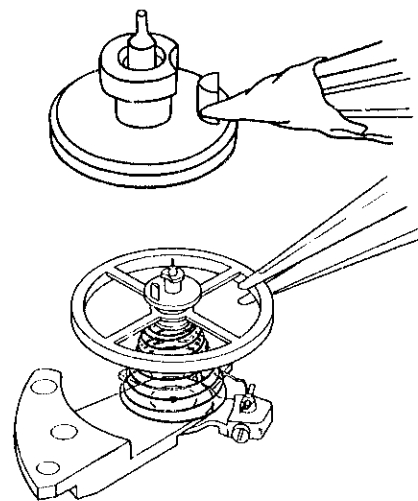

##### 2. Rinsing and drying

Rinse the balance in fresh benzene and slightly raise the balance with a pair of tweezers to prevent contact with the hairspring; then dry well, using a dryer or other means.

### 2. Regarding Modification of Parts

#### (1) Intermediate setting lever

The Intermediate setting lever, conventionally driven in the plate informer models, has been changed to the assembling type.

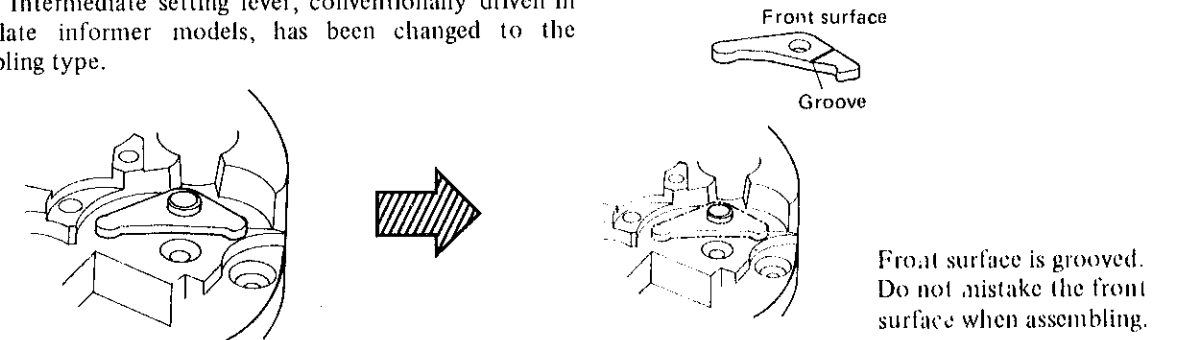

#### (2) Color of barrel cover

To clearly indicate use of SEIKO Watch Oil S-3, the barrel cover has been colored black.

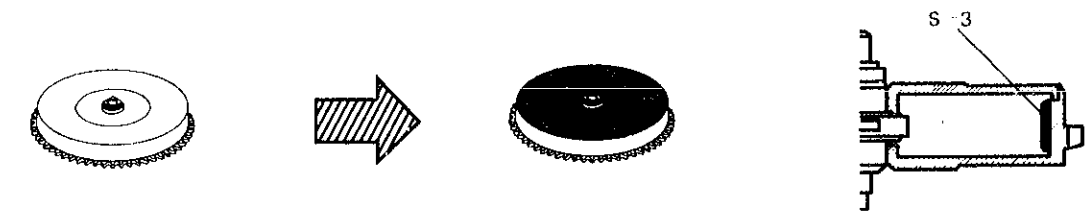

This implies the same meaning as the black ring mark on other watch types.

#### (3) Day jumper

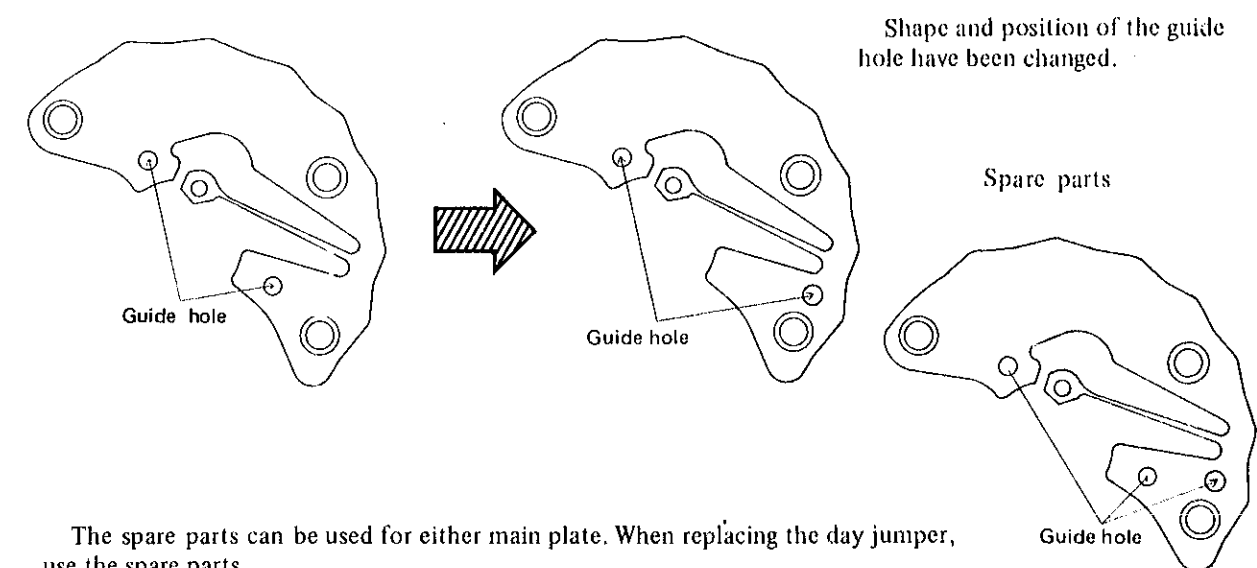

The spare parts can be used for either main plate. When replacing the day jumper, use the spare parts.