

# PARTS CATALOGUE/TECHNICAL GUIDE

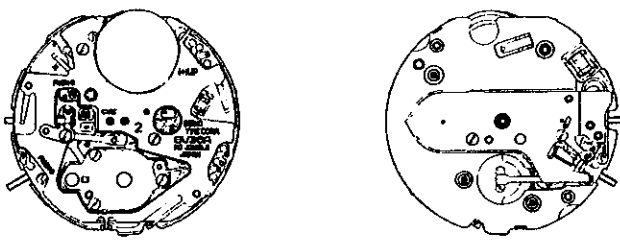

## Cal. 8V36A

### [SPECIFICATIONS]

Item		Cal. No.	8V36A
Movement			 <p style="text-align: right;">(x 1.0)</p>
Movement size	Outside diameter		ø31.8 mm
	Casing diameter		ø31.2 mm
	Height		4.19 mm (including battery portion)
Time indication			Three hands (Hour, minute and second hands) plus 24-hour hand and alarm hand
Driving system			Step motor
Additional mechanism			<ul style="list-style-type: none"> <li>• Ultrasonic alarm</li> <li>• Ultrasonic alarm engagement/disengagement</li> <li>• Train wheel setting device</li> <li>• Electronic circuit reset switch</li> <li>• Battery life indicator</li> </ul>
Loss/gain			Monthly rate at normal temperature range : less than 15 seconds
Regulation system			Nil
Measuring gate by quartz tester			Use 10-second gate.
Battery			SEIKO SR43W, Maxell SR43W, SONY SR43W, EVEREADY 386 Battery life is approximately 2 years. Voltage : 1.55 V
Jewels			0 jewel

Disassembling procedures Figs. : (1) → (59)  
 Reassembling procedures Figs. : (59) → (1)

**Lubricating: Types of oil**

-  Moebius A
-  SEIKO Watch Oil S-6
-  Silicone oil 500,000 c.s

**Oil quantity**

-  Normal quantity

**Remarks on removing and casing of the movement :**

Before removing the movement from the case or installing it in the case, be sure to set the alarm hand to the 6 o'clock position.

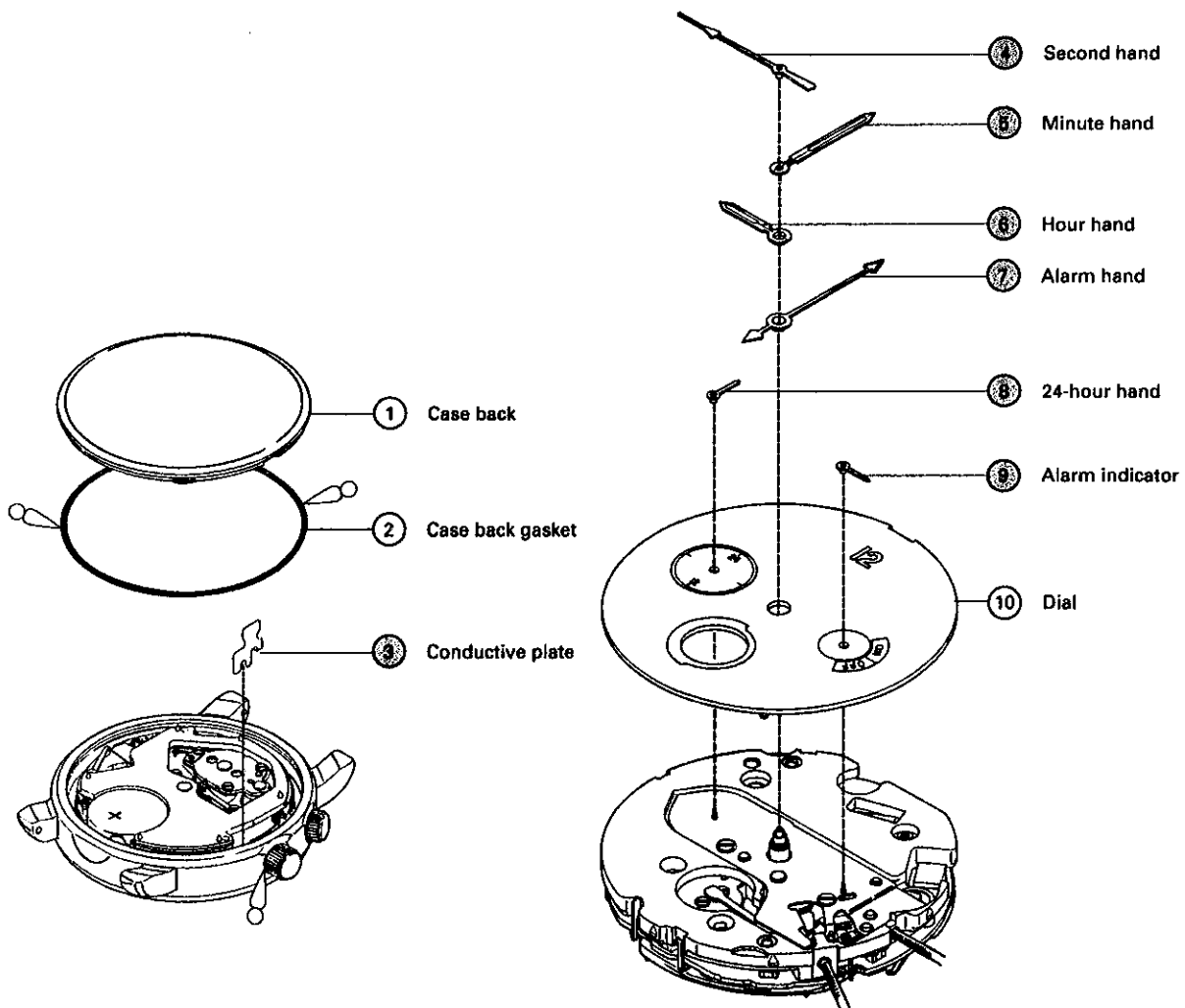

	0012 168
	• Circuit block cover screw
	• Train wheel bridge screw
	• Ultrasonic motor screw
	• Support for dial side parts screw
	• Alarm switch spring screw
	• Ultrasonic motor lead terminal screw

 → Please see the remarks on the following pages.

# PARTS CATALOGUE

Cal. 8V36A

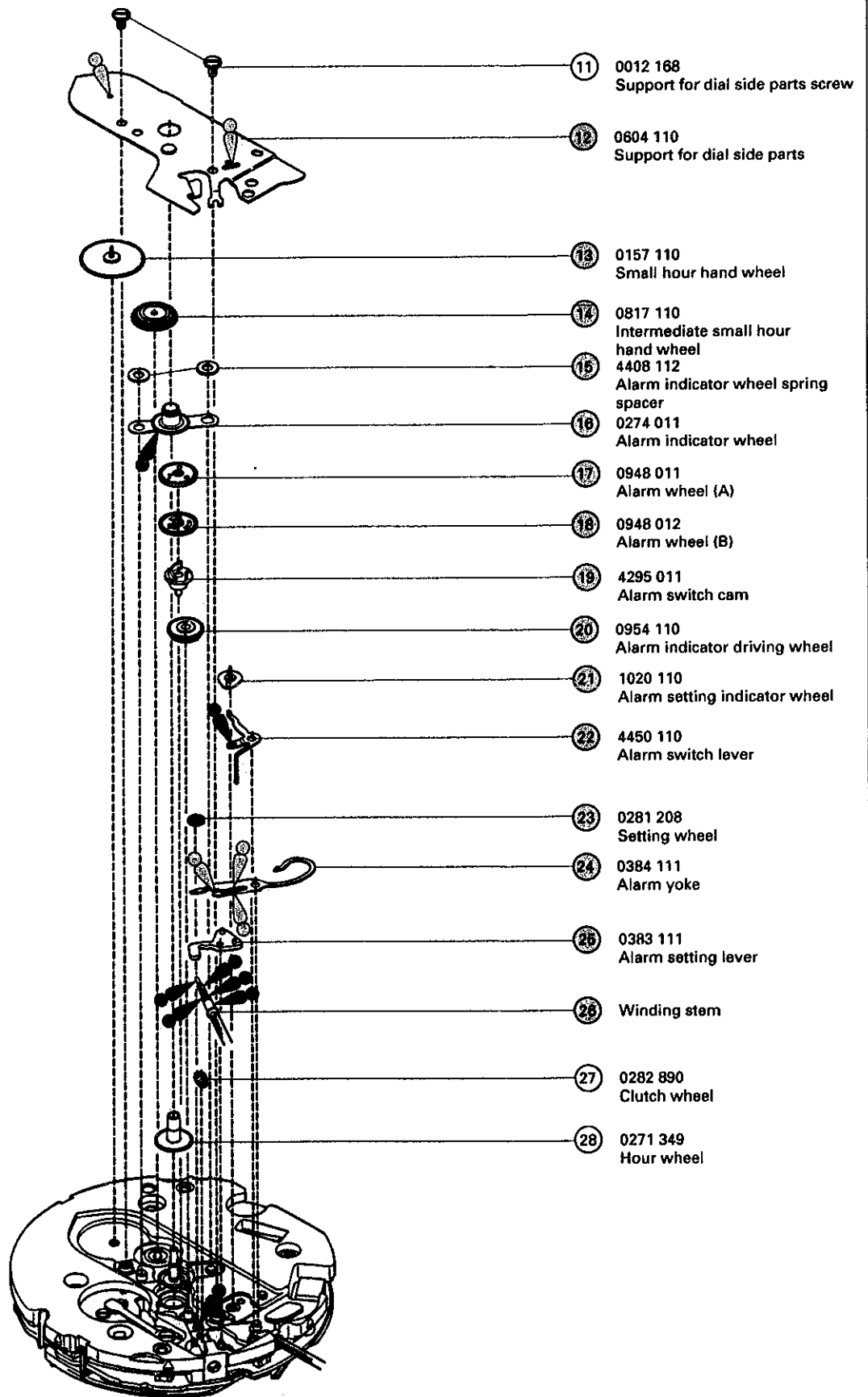

 Please see the remarks on the following pages.

# PARTS CATALOGUE

Cal. 8V36A

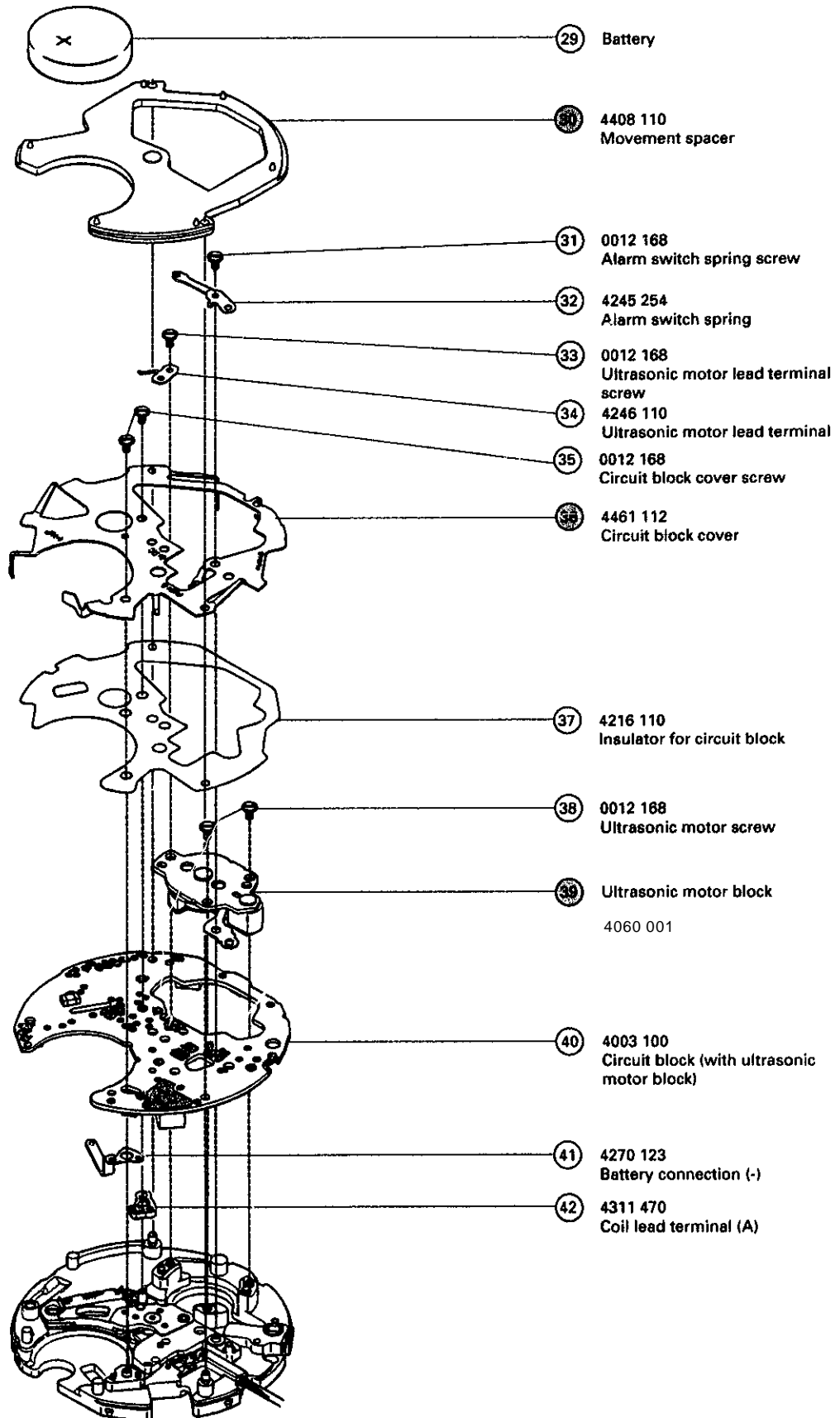

 Please see the remarks on the following pages.

# PARTS CATALOGUE

Cal. 8V36A

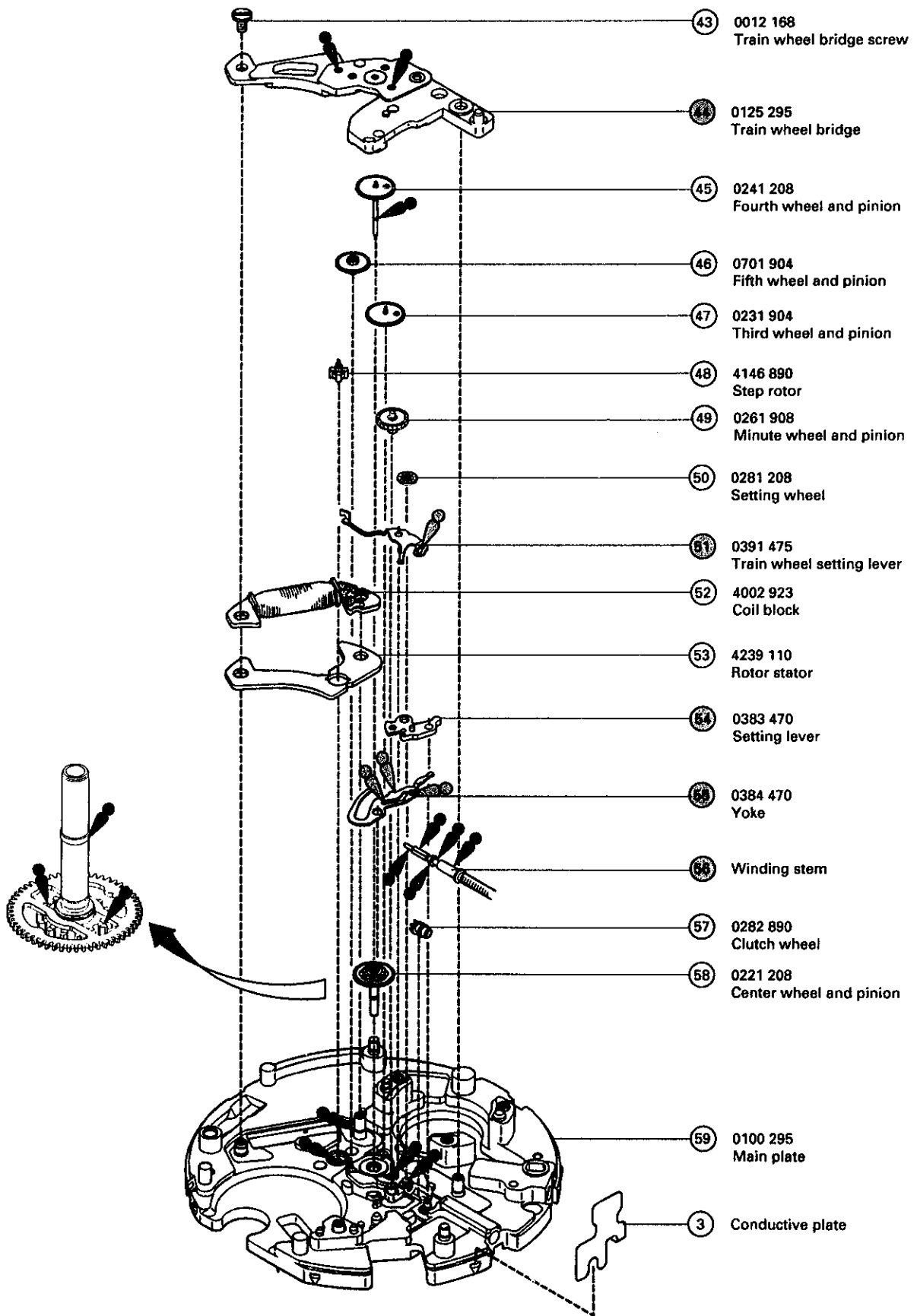

  Please see the remarks on the following pages.

**Remarks:**

0351 295

②⑥ ⑤⑥ Winding stem

\* The type of winding stem is determined based on the design of cases. Check the case number and refer to "SEIKO Parts Catalogue" to choose a corresponding winding stem.

## TECHNICAL GUIDE

- The explanation here is only for the particular points of Cal. 8V36A.
- For the repairing, checking and measuring procedures, refer to "TECHNICAL GUIDE , GENERAL INSTRUCTIONS".

### I. STRUCTURE OF CIRCUIT BLOCK

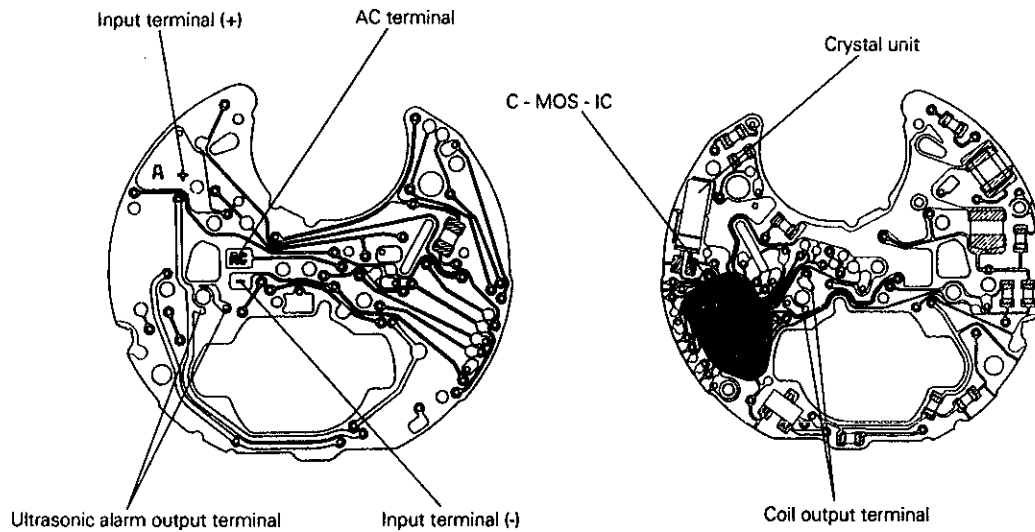

## II. REMARKS ON DISASSEMBLING AND REASSEMBLING

Use the universal movement holder for disassembling and reassembling.

### ③ Conductive plate

**• How to install**

Insert the conductive plate into a gap between the dial ring and main plate so that "A" and "B" portions of the conductive plate make contact with the notched portion of the main plate and the winding stem, respectively.

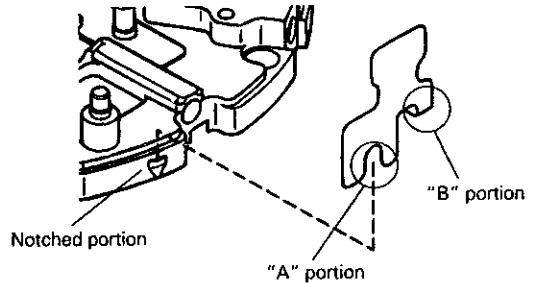

### ④ Second hand

### ⑤ Minute hand

### ⑥ Hour hand

### ⑦ Alarm hand

### ⑧ 24-hour hand

### ⑩ Movement spacer

**• How to install**

- 1) With the battery installed, set the movement spacer; then install each hand.
- 2) Check that the crowns at the 3 o'clock side and 4 o'clock side are at the normal position.
- 3) Install the alarm hand and turn the crown at the 4 o'clock side to set it to the 12 o'clock position. (The alarm hand should be turned clockwise)
- 4) Short-circuit "A" terminal (AC) of the circuit block and the circuit block cover with conductive tweezers.
- 5) Short-circuit "B" terminal of the circuit block and the circuit block cover with conductive tweezers. The wheels for the hour, minute and second hands on the train wheel bridge move quickly.
- 6) When the wheels on the train wheel bridge stop moving, the alarm switch spring ("C" portion) automatically makes contact with the circuit block to turn on the alarm. The wheels stop moving in less than 12 minutes.
- 7) After checking that the wheels stop moving by watching the third wheel and pinion through gap "D", install the hour, minute, second and 24-hour hands.
- 8) Install the minute hand at the 2 minute position in order to maintain the accuracy of the alarm.
- 9) After installing all the hands, short-circuit A terminal (AC) of the circuit block and circuit block cover.

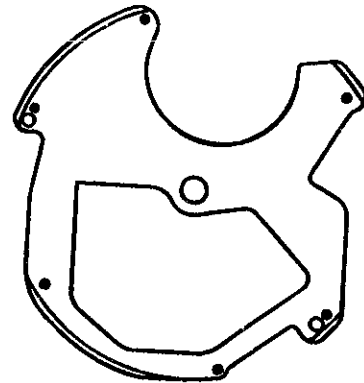

Movement spacer

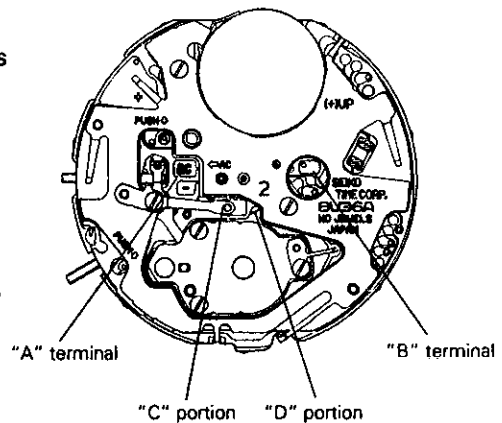

⑨ Alarm indicator

• How to install

Install the alarm indicator hand so that it points to the 17-minute position (OFF).

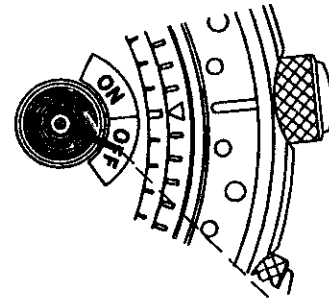

Setting position

⑰ Alarm wheel (A)

⑱ Alarm wheel (B)

⑲ Alarm switch cam

• Setting position

Refer to the illustration at right.

• Set the alarm wheels (A) and (B) with the surface facing notches up.

• Set the guide holes of the alarm wheel (B) securely onto the corresponding notched portions (each a different size) of the alarm switch cam.

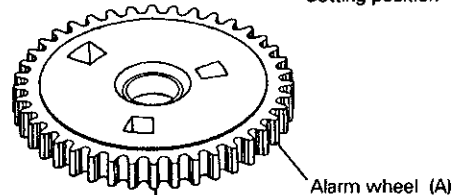

Alarm wheel (A)

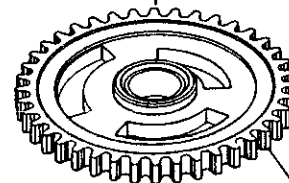

Alarm wheel (B)

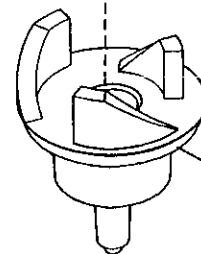

Alarm switch cam

⑳ Alarm switch lever

㉔ Alarm yoke

㉕ Alarm setting lever

• Setting position

Refer to the illustration below.

**Note** : When setting the alarm switch lever, take care not to deform the contact portion with the circuit block.

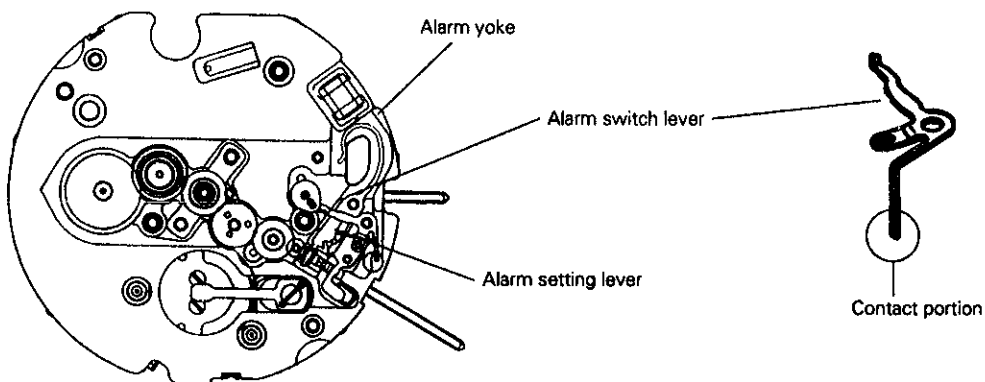

Alarm yoke

Alarm switch lever

Alarm setting lever

Contact portion



⑫ Support for dial side parts

⑬ ~ ⑳, ㉓

• Setting position of the alarm wheels

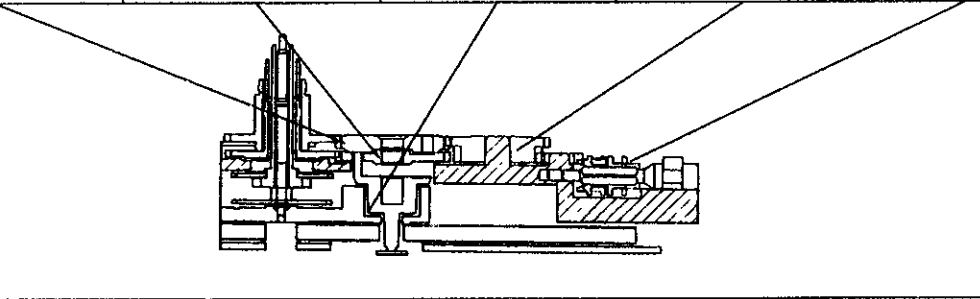
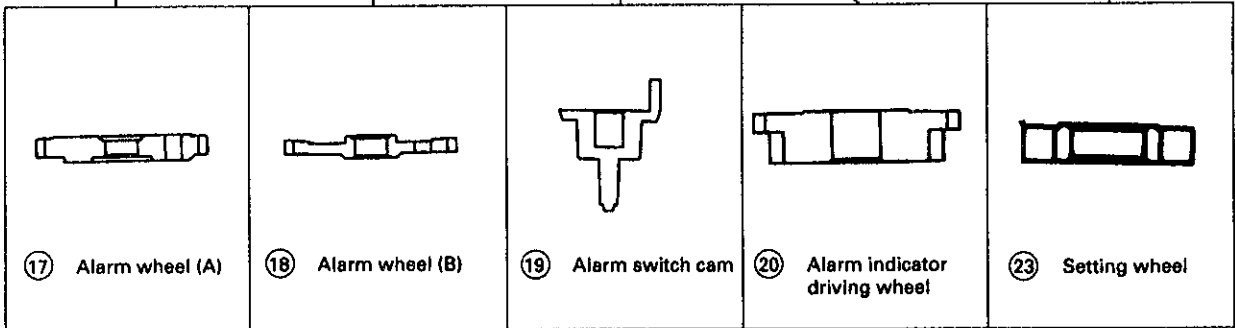
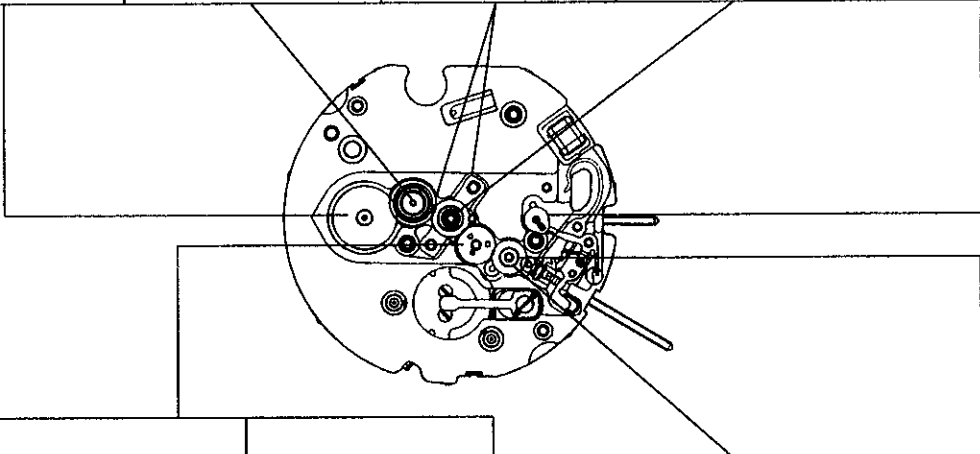
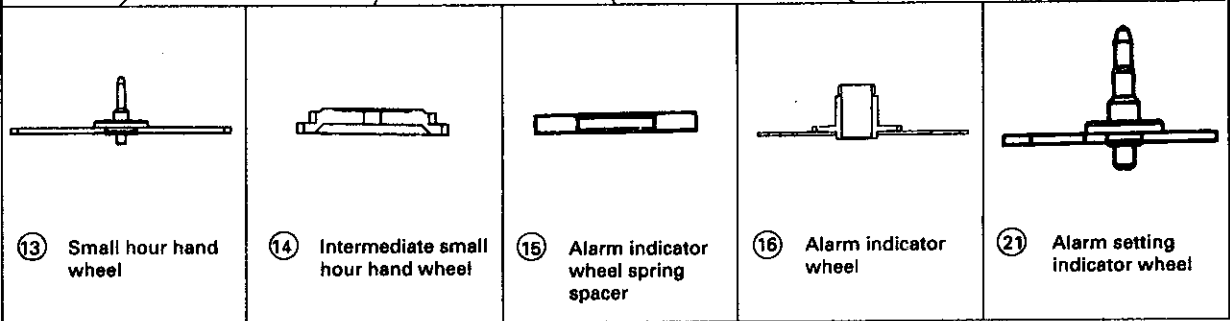
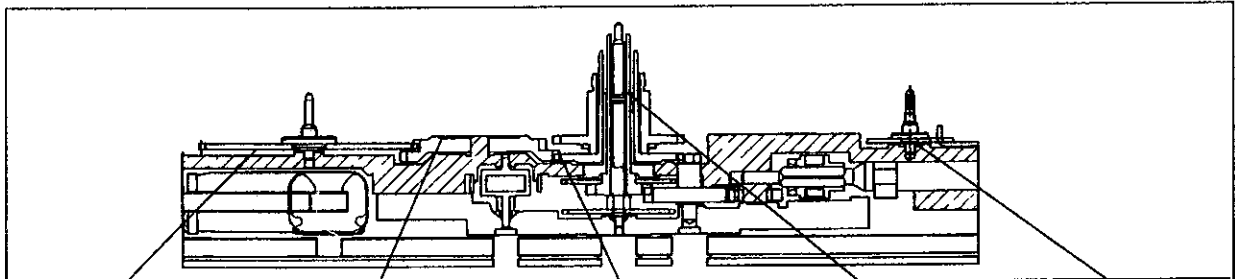

### 36) Circuit block cover

The circuit block cover is fixed to the main plate by the two hooking portions.

- Notes :**
- When disassembling or reassembling the circuit block cover, take care not to deform the hooking portions.
  - After installing the circuit block cover, check that the two hooking portions securely catch the main plate.

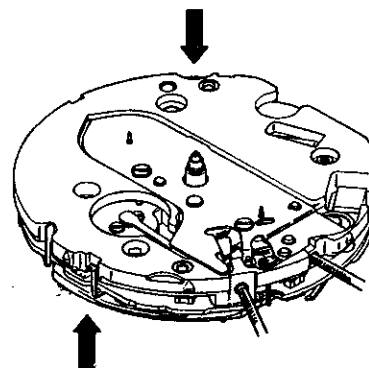

### 39) Ultrasonic motor block

**Note :** When handling the ultrasonic motor block with tweezers, hold it only by the portions indicated with "YES" in the illustration. Otherwise, the ultrasonic motor will malfunction.

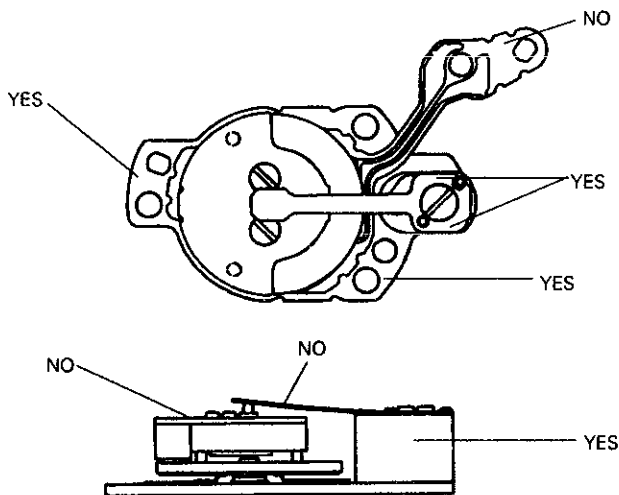

Each ultrasonic motor has its own characteristics, which are specifically encoded in the IC. When replacing the ultrasonic motor block or circuit block with new ones, replace both parts at the same time.

### 44) Train wheel bridge

• **Setting position**

Refer to the illustrations below to check where to install the respective wheels.

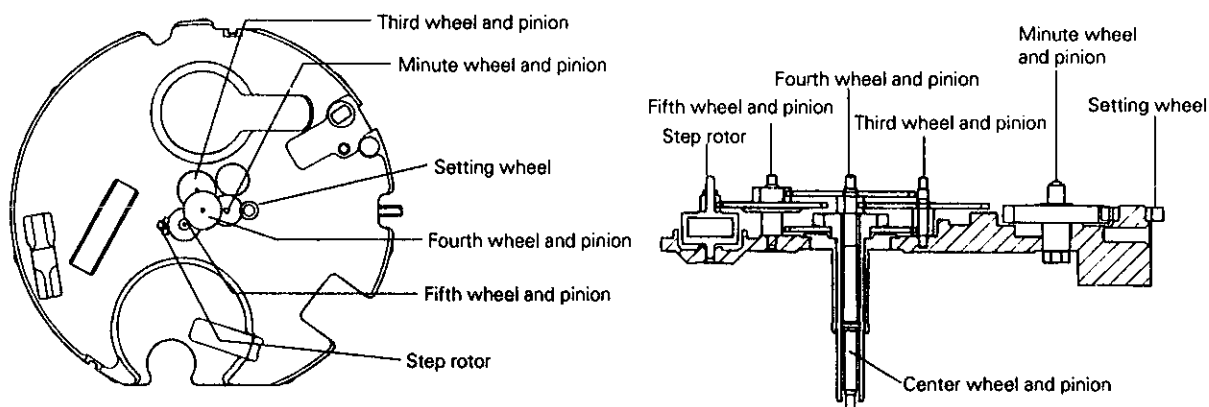

⑤1 Train wheel setting lever

⑤4 Setting lever

⑤5 Yoke

• **Setting position**

Refer to the illustration on the right.

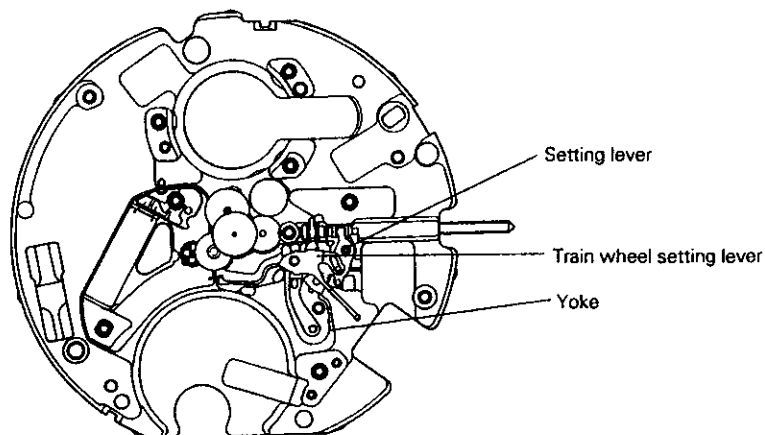

### III. VALUE CHECKING

• **Coil block resistance**

1.1K $\Omega$  ~ 1.5K $\Omega$

• **Current consumption**

For the whole movement : Less than 5.5 $\mu$ A

For the circuit block alone : Less than 1.4 $\mu$ A

**Remarks :**

When the current consumption exceeds the standard value for the whole movement but is within the standard value range for the circuit block alone, the watch is generating a driving pulse to compensate for the heavy load that may be applied to the train wheel, etc. In this case, overhaul and clean the movement parts and measure the current consumption for the whole movement again.

**How to check the accuracy of the alarm**

- Accuracy of the alarm : less than  $\pm$  5 minutes

**1) Set the alarm to a desired time.**

- To set the alarm to a time more than 2 hours ahead of the current time, turn the alarm hand counterclockwise.
- To set the alarm to a time less than 2 hours ahead of the current time, first advance the alarm hand more than 2 hours ahead of the current time and then turn it back to the exact alarm time.

**2) Turn the hour and minute hands ahead manually to the current fixed alarm time to confirm that the alarm rings within 5 minutes of the set time.**