

SEIKO

DIGITAL QUARTZ

Cal. B004A

**PARTS
CATALOGUE**

Cal. B004A

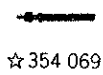
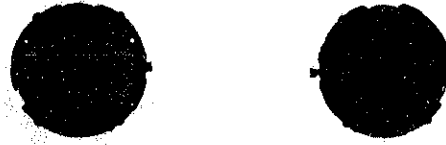

☆ 354 069



735 068

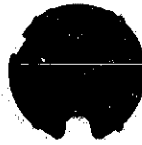

4001 216



4238 001



4246 015



4247 008



4256 006



4313 036



4398 213



4450 010



☆ 4510 062



4580 062



☆ 4991 002



☆ Maxell SR721W



012 462



017 524



Cal. B004A

Characteristics

Casing diameter : ϕ 17.5 mm
 Maximum height : 4.4 mm without battery
 Frequency of quartz crystal oscillator : 32,768 Hz (Hz=Hertz Cycles per second)
 Display medium : Nematic Liquid crystal, FE-Mode.
 Regulation system : Trimmer condenser
 Time and calendar display :
 Alarm display :
 Timer display :
 Time signal function :
 Sound demonstration :

PART NO.	PART NAME	PART NO.	PART NAME
☆354 069	Winding stem		
735 068	Winding stem holder		
4001 216	Circuit block		
4238 001	Switch lever spring		
4246 015	Lead terminal (+)		
4247 008	Winding stem holder bush		
☆4247 009			
4256 006	Speaker block fixing spring		
4313 036	Connector		
4398 213	Speaker block frame		
☆4398 335			
4450 010	Switch lever		
☆4510 062	Liquid crystal panel (Silver)		
☆4510 063	Liquid crystal panel (Gold)		
4580 062	Speaker block		
☆4580 064			
☆4991 002	Speaker gasket		
4991 152			
012 462	Winding stem holder screw		
017 524	Switch lever pin		
☆Maxell SR721W	Silver oxide battery		
SEIKO TR721W			

Remarks :

Winding system

☆354 069.....Refer to the photograph on the front page.

If the combination of the winding stem and case is unknown, check the case number and refer to "SEIKO Quartz Casing Parts Catalogue" to choose a corresponding winding stem.

Winding stem holder bush, Speaker block frame, Speaker block, Speaker gasket

☆4247 009 }
 ☆4398 335 }The parts designated with these parts numbers are manufactured specially for the water
 ☆4580 064 }resistant case of a pressure of 10 atmospheres (100 meters or 300 feet). Be sure to
 ☆4991 002 } use these parts for keeping high-water resistant quality.

Liquid crystal panel

☆4510 062 }Be sure that combination between the color of panel cover and liquid crystal panel should
 ☆4510 063 } be matched according to the "SEIKO Quartz Casing Parts Catalogue."

Battery

☆Maxell SR721W }The substitutive battery might be added to the applied battery in the future.
 ☆SEIKO TR721W } In that case please refer to separate "BATTERY LIST FOR SEIKO QUARTZ WATCHES".

☆⇨ Please see remarks.

Part numbers in light letters are not shown in photos.

TECHNICAL GUIDE

SEIKO DIGITAL QUARTZ

CAL. B004A

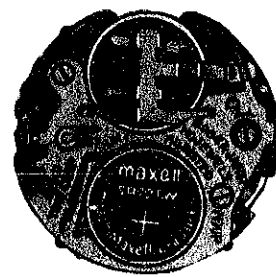

CONTENTS

I. SPECIFICATIONS	1
II. STRUCTURE OF CIRCUIT BLOCK	1
III. DISPLAY FUNCTION	2
IV. DISASSEMBLING, REASSEMBLING AND LUBRICATING OF CASE	3
V. DISASSEMBLING AND REASSEMBLING	4
1. Liquid crystal panel side	4
2. Battery side	5
3. Relationship between the segment (Liquid crystal panel electrode) and the C-MOS-LSI output terminal	6
VI. CHECKING AND ADJUSTMENT	7
• Check battery voltage	7
• Check battery conductivity	7
• Check current consumption	7
• Check water resistance	8
• Check contact between C-MOS-LSI and liquid crystal panel	8
• Check liquid crystal panel and circuit block	8
• Check accuracy	8
• Check functioning	8
• Check alarm test system	9
• Check conductivity of switch component	9
• Check speaker block	9
• Others	9

I. SPECIFICATIONS

Cal. No.		B004A
Item		
Display medium		Nematic Liquid Crystal, FEM (Field Effect Mode)
Liquid crystal panel driving system		Multiplex driving system
Display system		Time function Calendar function Alarm function Timer function
Additional mechanism		Automatic calendar system Hourly time signal Alarm test system
Loss/gain		Monthly rate at normal temperature range: Less than 15 seconds
Module size	Outside diameter	φ17.5 mm
	Height	4.4 mm without battery
Regulation system		Trimmer condenser
Measuring gate by quartz tester		Any gate is available
Battery		SEIKO (SEIZAIKEN) TR721W, Maxell SR721W Battery life is approximately 2 years Voltage: 1.55V

II. STRUCTURE OF CIRCUIT BLOCK

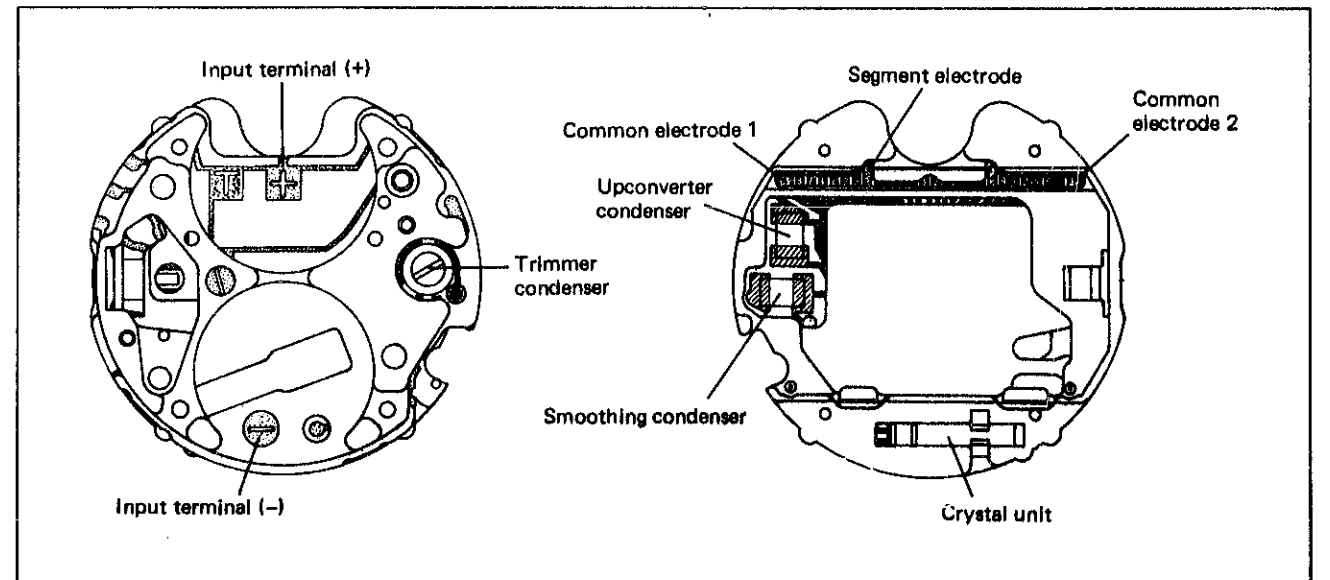

III. DISPLAY FUNCTION

Time display

- Each time the crown is turned clockwise, the display will change in the order below.

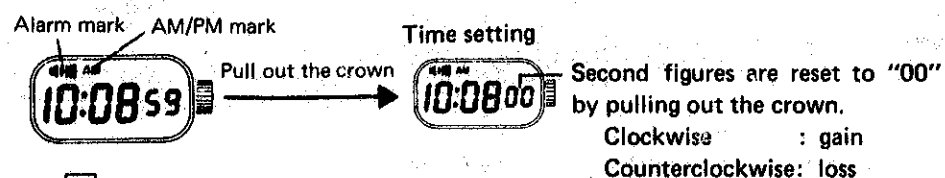

Clockwise

- How to operate alarm test system
In the time function, turn the crown clockwise and counterclockwise twice within 2.5 seconds.

Day and date display



Clockwise

Month and date display

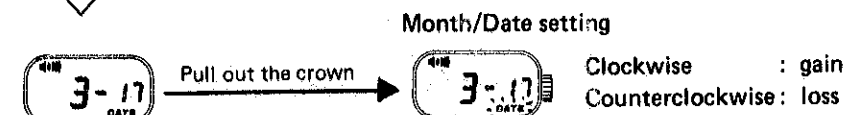

Clockwise

Alarm display

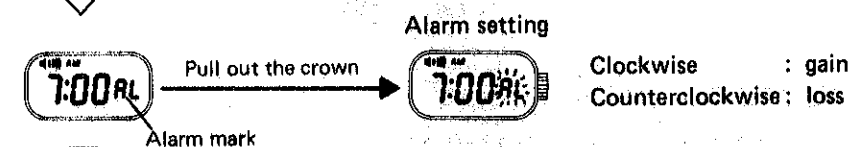

Clockwise

- How to engage or disengage the alarm
In the alarm function, the alarm mark appears and disappears alternately with each push of the crown and the alarm is engaged and disengaged respectively.
- How to stop the alarm from ringing
Turn the crown once clockwise and counterclockwise.

Timer display

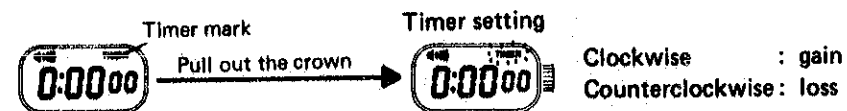

- How to start and stop timer
Push in the crown to start it and pull out the crown to stop it.
- How to reset timer
Turn the crown and set it to "0:00 00".

Note: Display changes quickly by turning the crown quickly.

IV. DISASSEMBLING REASSEMBLING AND LUBRICATING OF CASE

Disassembling procedures: Figs. ① → ⑥

Reassembling procedures: Figs. ⑥ → ①

Lubricating: ● SEIKO Watch Oil-S6
Never lubricate the portion marked ⊗

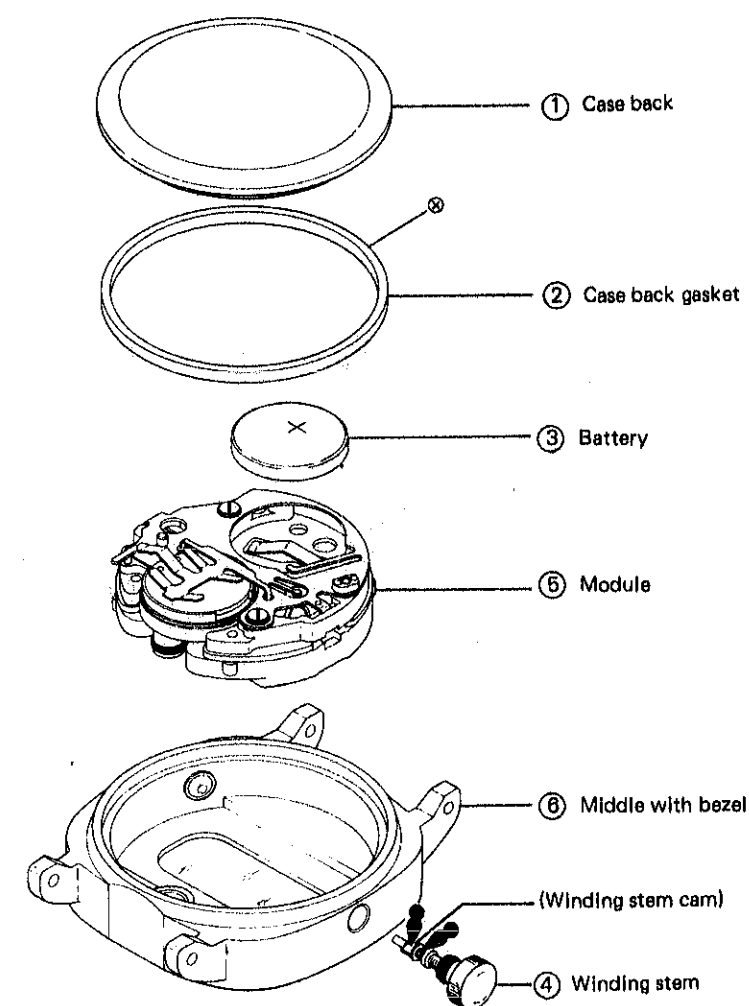

④ Winding Stem

When removing/installing winding stem, depress the punched part of the winding stem holder downward with tweezers. At the same time, pull out/insert the winding stem so that the cam is placed horizontally.

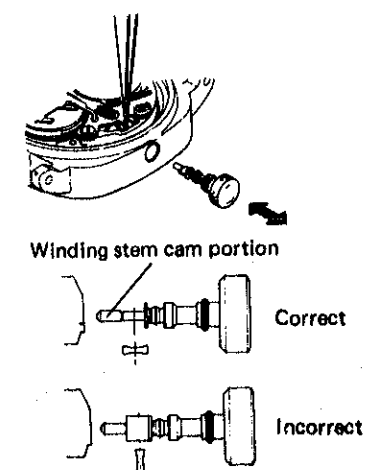

V. DISASSEMBLING AND REASSEMBLING

Disassembling procedures: Figs. ① → ⑪

Reassembling procedures: Figs; ⑪ → ①

1. Liquid crystal panel side

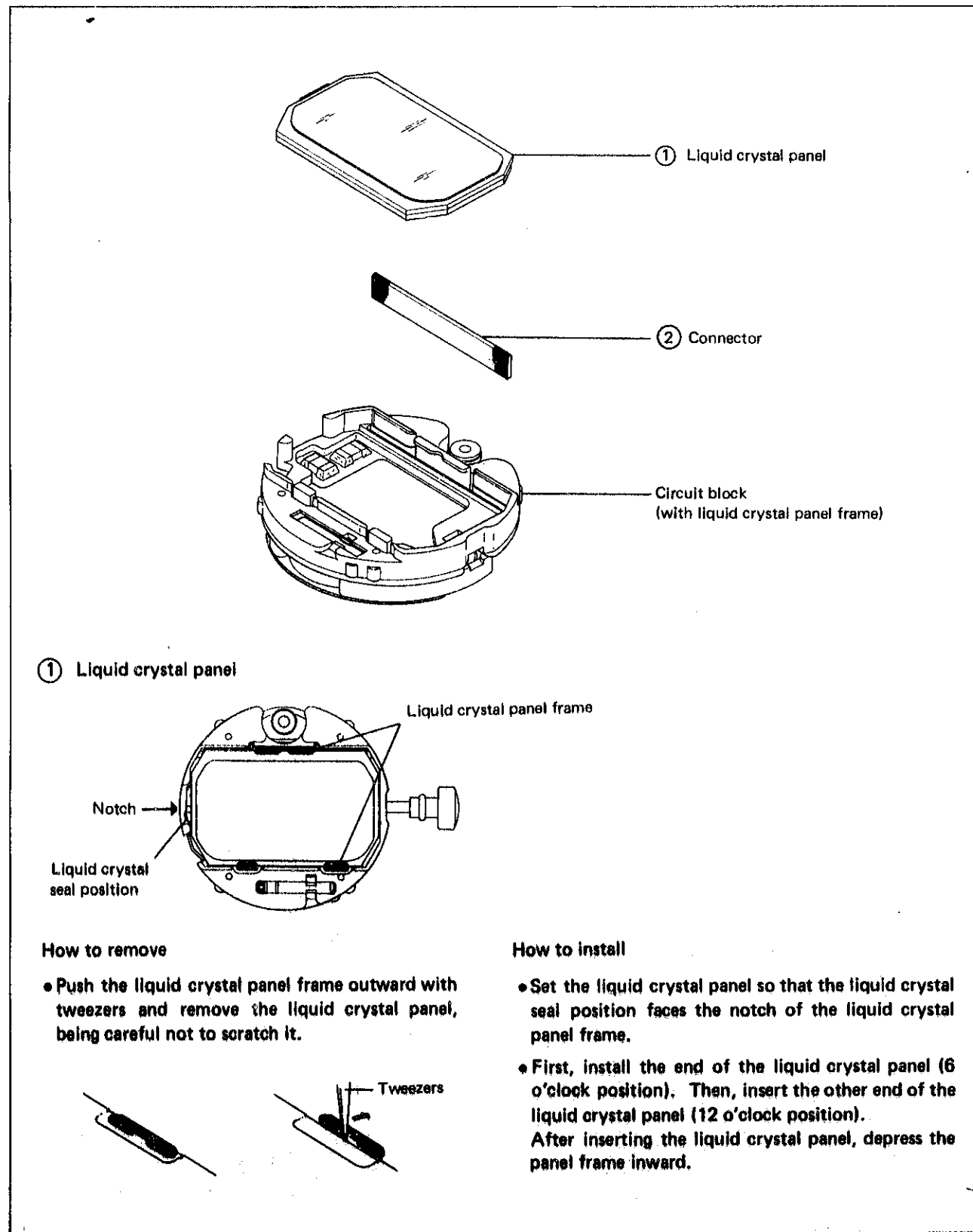

2. Battery side

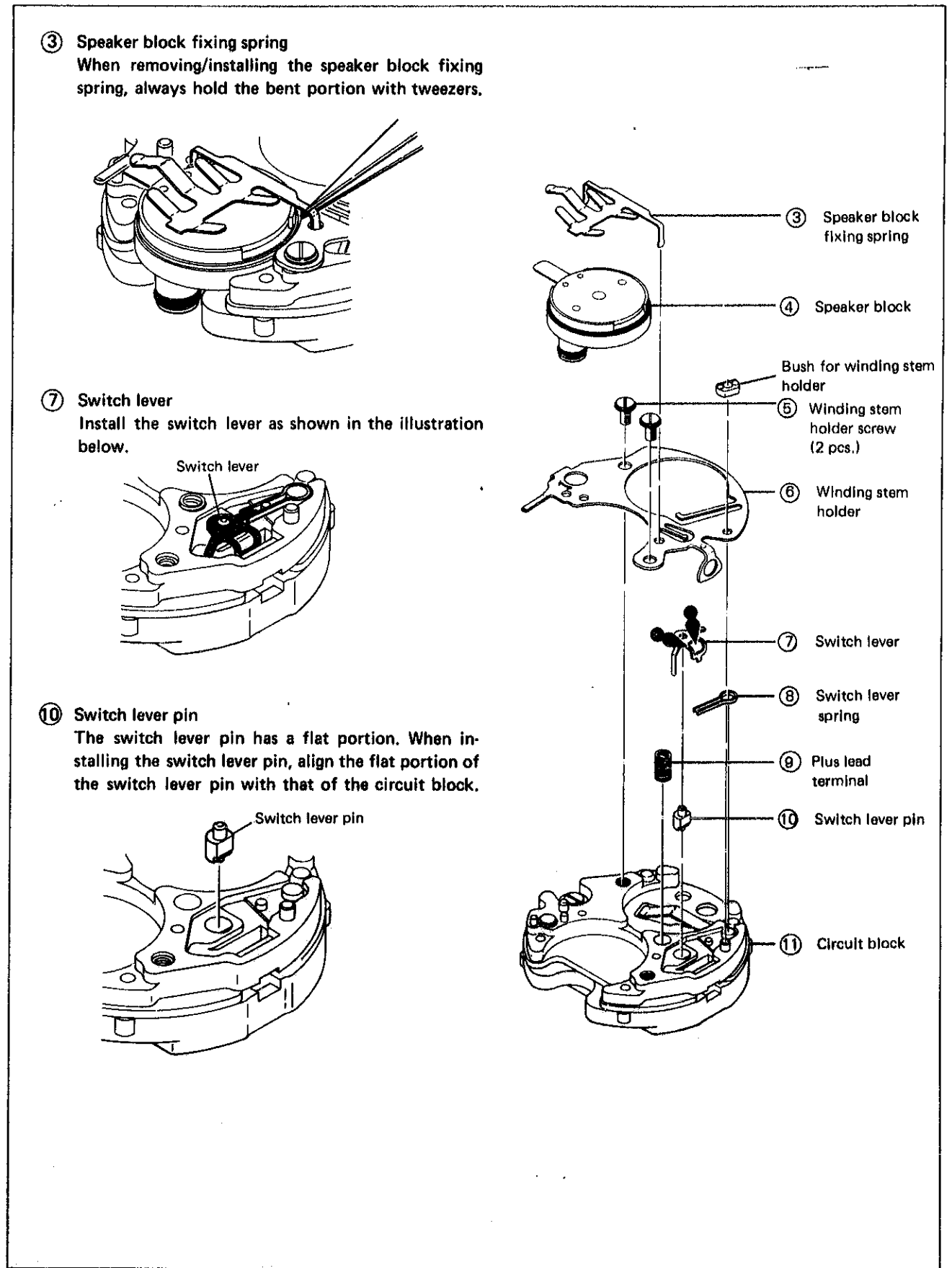

3. Relationship between the segment (Liquid crystal panel electrode) and the C-MOS-LSI output terminal

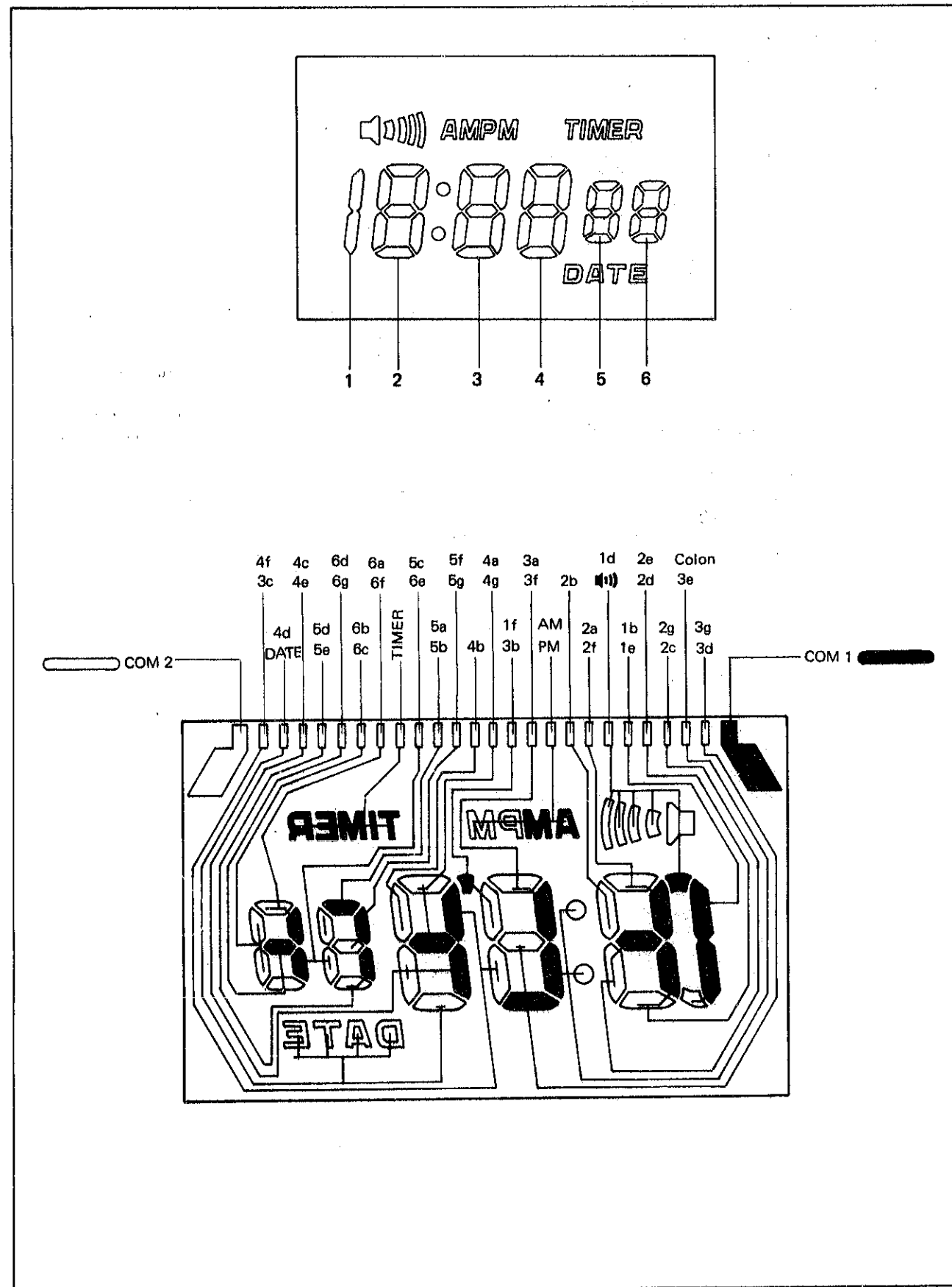

VI. CHECKING AND ADJUSTMENT

The explanation here is only for the particular points of Cal. B004A.
Refer to the "TECHNICAL GUIDE, GENERAL INSTRUCTION" for SEIKO Digital Quartz for ordinary checking and adjustment.

Procedure	
CHECK BATTERY VOLTAGE	
<p>Set up the Volt-ohm-meter. Range to be used: DC3V</p> <p>Red probe ⊕ Battery surface ⊕ Black probe ⊖ Battery surface ⊖</p>	<p>Result: Normal : More than 1.5V Defective : Less than 1.5V Replace the battery.</p>
CHECK BATTERY CONDUCTIVITY	
CHECK CURRENT CONSUMPTION	
<ul style="list-style-type: none"> Be sure to protect the C-MOS-LSI from light with black paper etc., while measuring. Do not check current consumption under an incandescent lamp, since strong light causes a watch to consume excess current. Set up the Volt-Ohm-meter. Range to be used: DC12μA <p>Red probe ⊕ Battery connection ⊖ Black probe ⊖ Battery surface ⊖</p>	<p>Result: Normal : Less than 1.5μA Defective : More than 1.5μA *Replace circuit block or liquid crystal panel.</p>
<p>How to find defects when the current consumption is more than 1.5μA. Measure the current consumption of circuit block alone.</p>	<p>Normal : Less than 1.3μA Replace the liquid crystal panel.</p> <p>Defective : Replace the circuit block.</p>

Procedure

CHECK WATER RESISTANCE

CHECK CONTACT BETWEEN C-MOS-LSI AND LIQUID CRYSTAL PANEL

Refer to "Relation between the segment and C-MOS-LSI output terminal" and check for poor conductivity of the liquid crystal panel, connector and C-MOS-LSI output terminal.

CHECK LIQUID CRYSTAL PANEL AND CIRCUIT BLOCK

(1) Check to see if there are any broken wire, short circuit, etc. in the liquid crystal panel.

Set up the Volt-ohm-meter
Range to be used: OHMS x1 - x1K

Result:
Normal : Lights up
Defective : Does not light up.
Replace the liquid crystal panel.

(2) Check to see if the electric signal is transmitted correctly from the circuit block.
When measuring, be sure to remove liquid crystal panel, connectors and speaker block.

Set up the Volt-ohm-meter.
Range to be used: DC3V

Result:
Normal : More than 0.8V
Defective : Less than 0.8V
Replace the circuit block.

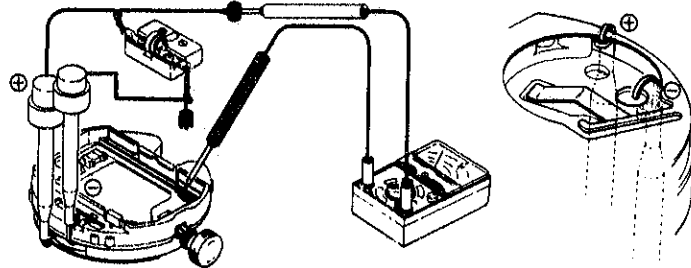

CHECK ACCURACY

- When measuring time accuracy, set the watch in the timer function where the timer mark is not flashing and the display is reset to "0:0000".
- Be sure to protect the C-MOS-LSI from light with case back or black paper, etc. while measuring.

Result:
Normal : Neither gain nor loss.
Defective : Either gain or loss.

CHECK FUNCTIONING

Procedure

CHECK ALARM TEST SYSTEM

In the time display, turn the crown clockwise and counterclockwise twice within 2.5 seconds and the alarm will ring five times.

Result:
Normal : Alarm rings
Defective { Alarm does not ring
Check speaker block
Display disappear
Replace battery.

CHECK CONDUCTIVITY OF SWITCH COMPONENT

- Check to see if the contact points of switch lever touch the circuit block in fully assembled module.
- With the middle with bezel assembled check to see if the display changes correctly by turning crown clockwise and counterclockwise.

Result:
Normal : Operate correctly.
Defective : Do not operate correctly.

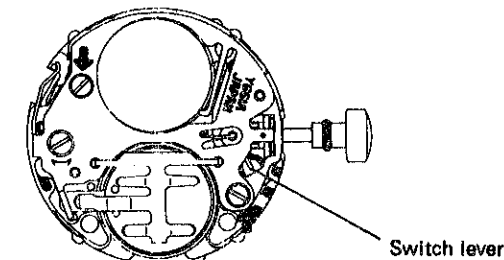

CHECK SPEAKER BLOCK

Set up the Volt-ohm-meter
Range to be used: OHMS x 100

Result:
Normal : 120Ω - 140Ω
Defective { Less than 120Ω
(Short circuit)
More than 140Ω
(Broken wire)
Replace speaker block.

OTHERS

If all segments are displayed and don't return to the normal display condition, open the case back and remove the battery. Then short circuit the battery connection (-) and winding stem holder with tweezers.