

TECHNICAL GUIDE

CAL. Y816A
CAL. Y819A

DIGITAL QUARTZ

CONTENTS

I. SPECIFICATIONS	1
II. CIRCUIT SCHEMATIC	1
III. DISASSEMBLING AND REASSEMBLING	2
IV. CLEANING	3
V. CHECKING AND ADJUSTMENT	4 ~ 9
1. Guide table for checking and adjustment	4
2. Procedure for checking and adjustment	5 ~ 9
A. Check battery voltage	5
* Check pattern of segments	5
B. Check conductivity of liquid crystal panel, circuit block and connector	5
C. Check circuit block and liquid crystal panel	5 ~ 6
D. Check current consumption	7
E. Check accuracy	8
F. Check conductivity of switch components	8
G. Check alarm function	8
H. Check functioning and adjustment	9

I. SPECIFICATIONS

Item	Cal No.	Y819A	Y816A
Display medium		Nematic Liquid Crystal, FEM (Field Effect Mode)	
Liquid crystal panel drive system		Multiplex	
Display system		<ul style="list-style-type: none"> ● Time display ← ● Calendar display ← ● Stopwatch display ← ● Alarm display ← 	
Additional mechanism		<ul style="list-style-type: none"> ● 12-hour/24-hour changeover system ← ● Time signal function ← ● Alarm test system ← 	
Loss/gain		Loss/gain at normal temperature range. Monthly rate: Less than 20 seconds	
Casing diameter		φ18.7 mm	
Height		5.1 mm (including battery)	
Regulation system		Trimmer condenser	
Quartz tester measuring gate		Any gate is available.	
Battery		Battery life: Approx. 3 years	
		U.C.C. 391 MAXELL SR1120W TOSHIBA SR1120W SEIZAIKEN TR1120W	MAXELL SR1120SW SEIZAIKEN TR1120SW
		Voltage: 1.55V	

II. CIRCUIT SCHEMATIC

The illustrations below is the circuit schematic of Cal. Y819. In the circuit block of Cal. Y816, the up converter coil and transistor are not installed.

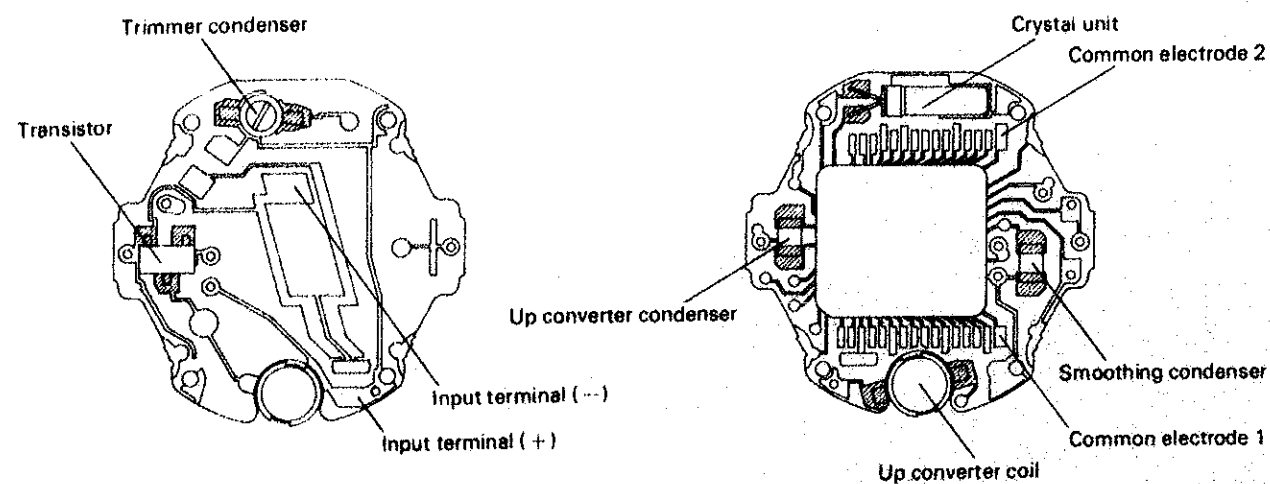

III. DISASSEMBLING AND REASSEMBLING

- Disassembling procedures: Figs. ① - ⑩
- Reassembling procedures: Figs. ⑩ - ①

① Battery clamp

Removal

In the battery clamp, two hooks are provided and one has a boss. When removing the battery clamp, push the boss outward with tweezers.

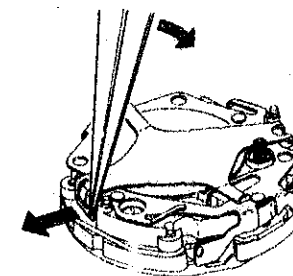
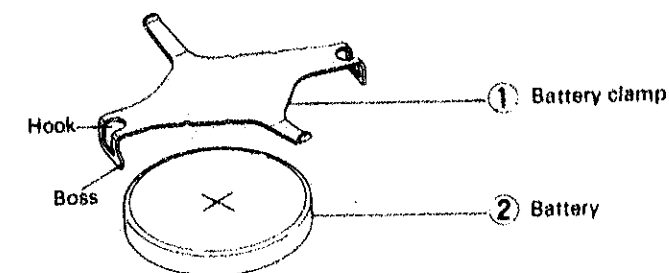

Installation

Installation the battery clamp so that the boss is engaged with the notch of the battery guard.

④ Battery guard

The battery frame is installed with 4 pins (arrows) inserted into panel frame.

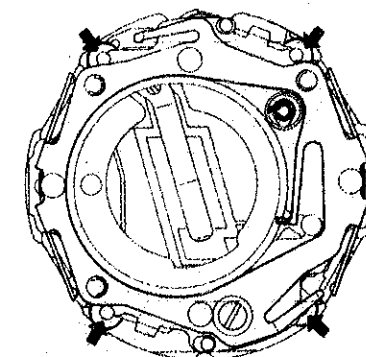

Removal

Insert a screwdriver between the battery guard and circuit block in the vicinity of pins and pry out the battery guard.

Installation

Press in the battery guard so that there is not gap between the battery guard and circuit block.

③ Speaker lead terminal

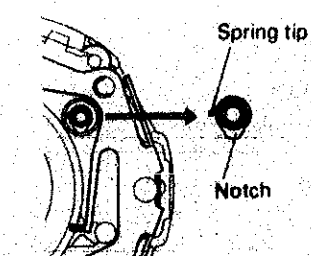

Turn the spring so that the spring tip is aligned with the notch to remove or install the speaker lead terminal.

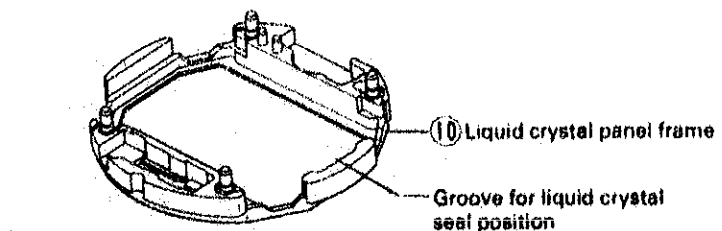
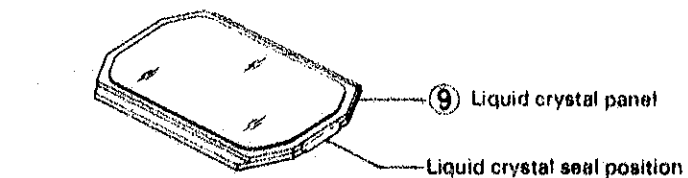
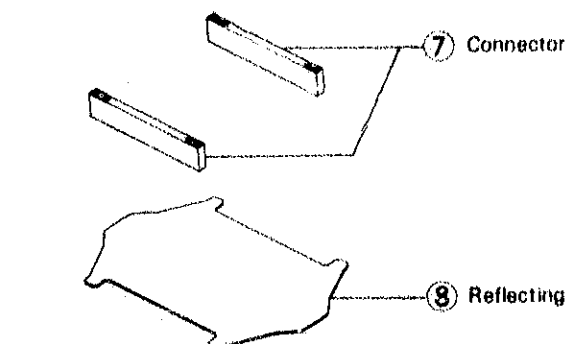
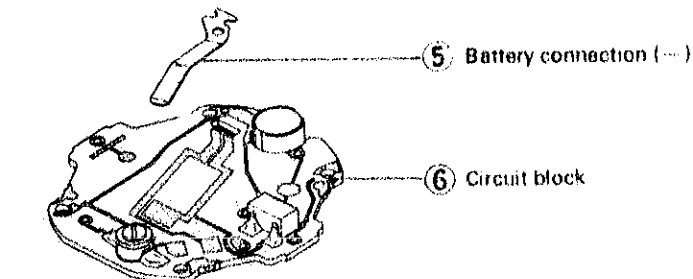
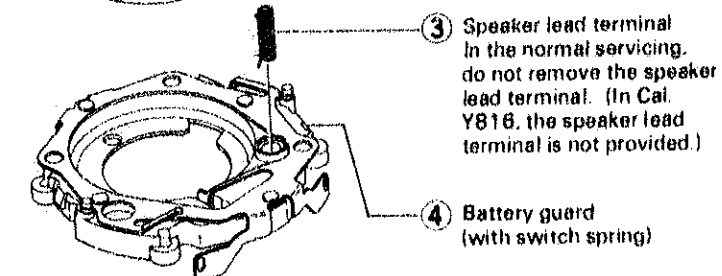

IV. CLEANING

For cleaning, refer to table below.

Name of parts	Cleaning	Drying	Solution	Remarks
Connector	Rinse or wash with a soft brush.	Warm air	Alcohol	<ul style="list-style-type: none"> ● Clean the contacting portion between the connector and liquid crystal panel and circuit block. ● Never use benzene or trichloroethylene as these will melt the parts. ● Do not set the connector until it is completely dry.
Plastic parts	Rinse or wash with a soft brush.	Warm air	Alcohol or benzene	
Others (except the parts that must not be cleaned.)	Rinse and wash with a cleaner or wash with a soft brush.	Warm or hot air	Benzene or alcohol	

- Parts that must not be cleaned

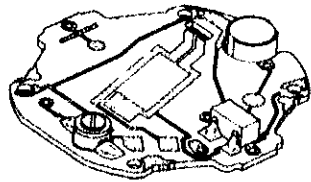

Circuit block

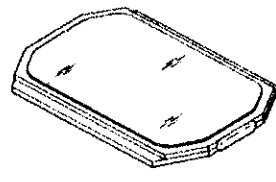

Liquid crystal panel

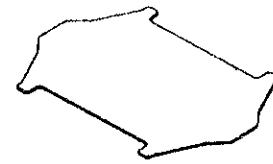

Reflecting mirror

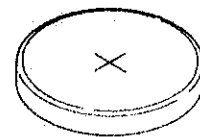

Battery

- Only the conductive portions should be wiped with a cloth moistened with benzene and dried with warm air.
- Remove dust and lint with a brush.
- Be careful not to scratch the front surface of the reflecting mirror.

V. CHECKING AND ADJUSTMENT

1. Guide table for checking and adjustment

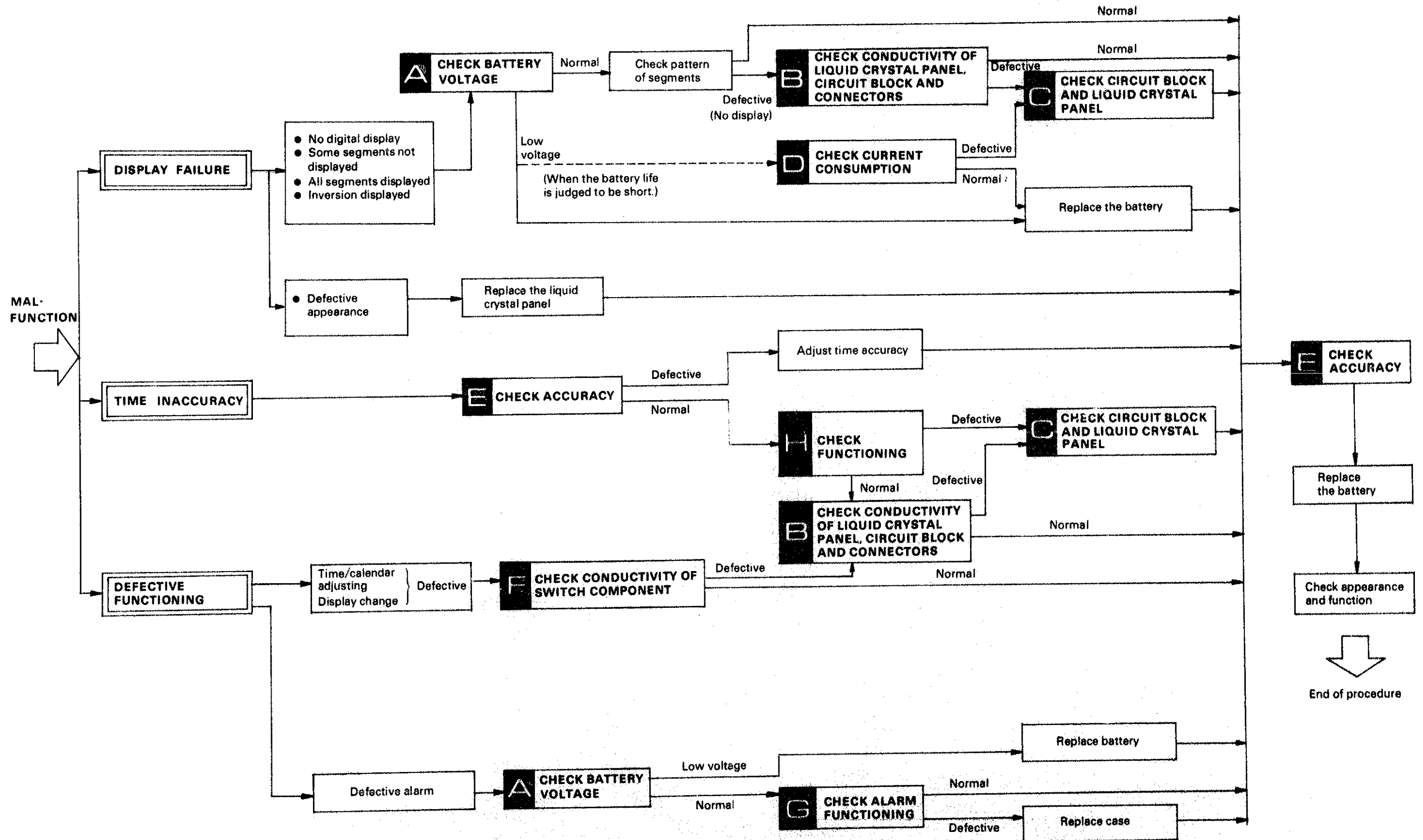

2. Procedure for checking and adjustment

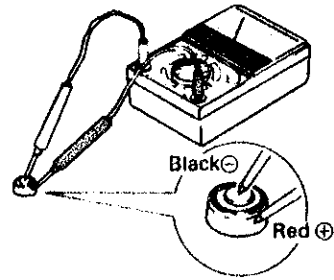
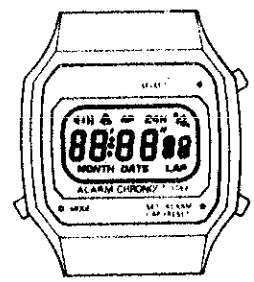
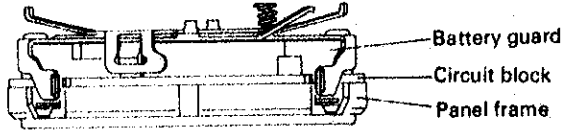
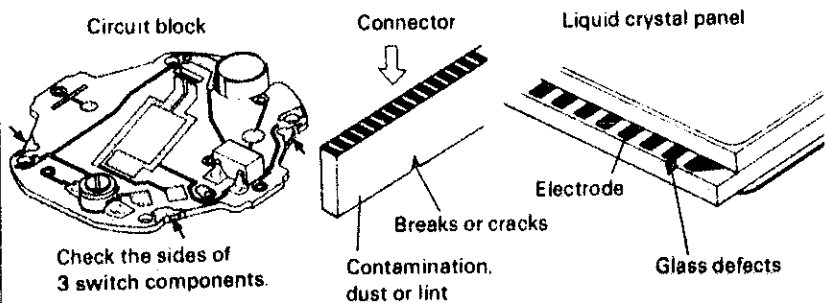
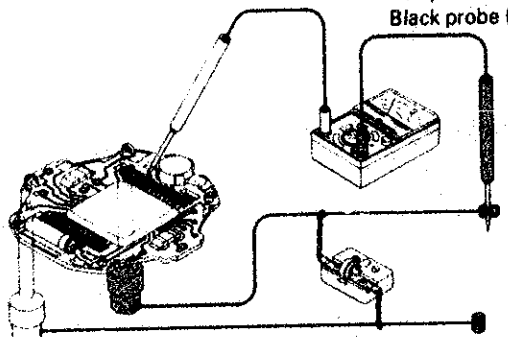
	Procedures	Results and repair
CHECK BATTERY VOLTAGE	<p>Check battery voltage. Set up the Volt-ohm-meter. Range to be used: DC3V</p> <p>● Measuring Red probe (+)... Battery surface (+) Black probe (-)... Battery surface (-)</p> 	<p>1.5V or more... Normal Less than 1.5V... Defective Replace the battery.</p>
CHECK PATTERN OF SEGMENTS	<p>In the time display mode, depress button (A) three times to enter the watch into time setting mode. Depress buttons (B) and (C) simultaneously to enter the watch into pattern segment checking mode. Check the defective segment. To release the pattern segment checking mode, depress button (A).</p> 	<p>All segment displayed... Normal Some segments not displayed... Defective Proceed to (B) and (C)</p>
CHECK CONDUCTIVITY OF LIQUID CRYSTAL PANEL, CIRCUIT BLOCK AND CONNECTOR	<p>(1) Check that there is no gap between the circuit block and battery guard.</p>  <p>(2) Check for dust, lint and other contamination, breaks, scratches or cracks on the conductive portions.</p> 	<p>There is not gap... Normal Proceed to (B) (2). There is a gap... Defective Press in the battery guard again.</p> <p>No dust, lint or contamination... Normal Dust, lint or contamination... Defective Remove any foreign matters.</p> <p>No breaks, cracks or scratches... Normal Breaks, cracks or scratches... Defective Replace with a new one.</p>
CHECK CIRCUIT BLOCK AND LIQUID CRYSTAL PANEL	<p>(1) Check that the electric signal flows into the connector from the circuit block correctly.</p> <p>1 Remove the circuit block from the module. 2 Supply power to the circuit block. Set up the Volt-ohm-meter.</p> <p>Range to be used: DC3V Red probe (+)... Power supply (+) Black probe (-)... Segment electrode</p> 	<p>0.8V or more... Normal Less than 0.8V... Defective Replace the circuit block.</p>

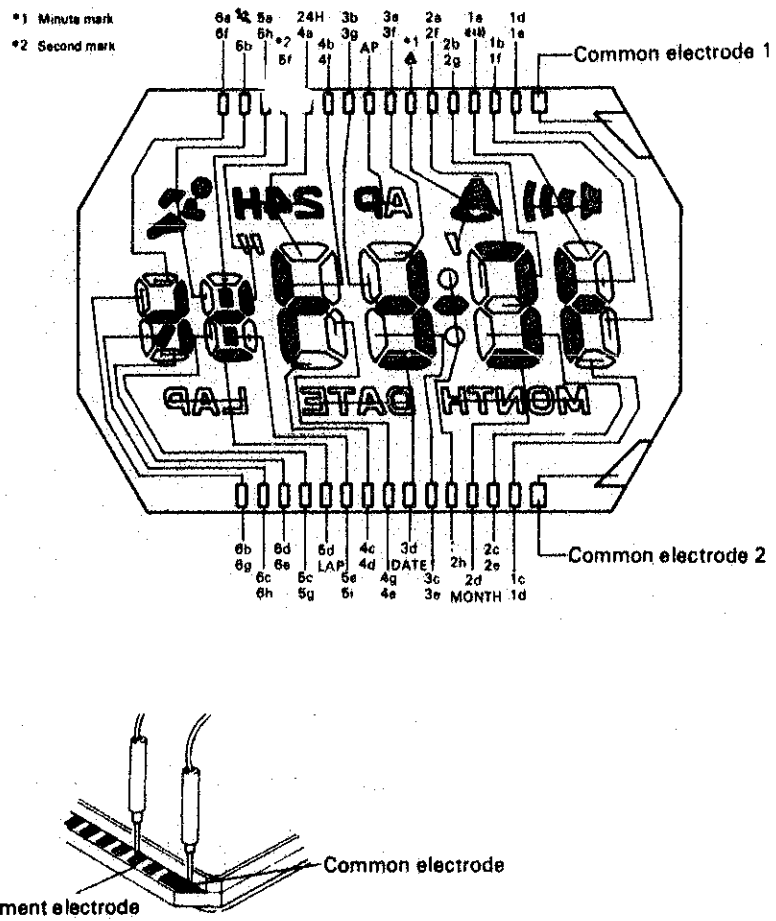
	Procedures	Results and repair
CHECK CIRCUIT BLOCK AND LIQUID CRYSTAL PANEL	<p>(2) Check for broken connecting leads, short circuit, etc. of the liquid crystal panel.</p> <p>1 Turn the liquid crystal panel to the reverse side. 2 Set up the Volt-ohm-meter. Range to be used: R x 1 (Any range will do if more than 3V is applied to the terminal of the Volt-ohm-meter.) 3 Apply the probes to the common electrode and the segment electrode of the liquid crystal panel. (Either red or black probe will do.) Common electrode (1) is connected electrically with () segment. Common electrode (2) is connected electrically with () segment.</p>  <p>Two common electrodes are provided on the liquid crystal panel. Each segment is displayed by the potential difference between each segment and one of the two common electrodes.</p> <p>[NOTE] The same liquid crystal panels are used in Cals. Y819 and Y816. In Cal. Y816, the alarm mark and time signal mark are displayed when the probes are applied. In normal operation, these marks are not displayed because of the different ICs.</p>	<p>Displayed... Normal Not displayed... Defective Replace the liquid crystal panel.</p>

Procedures

[Y819]

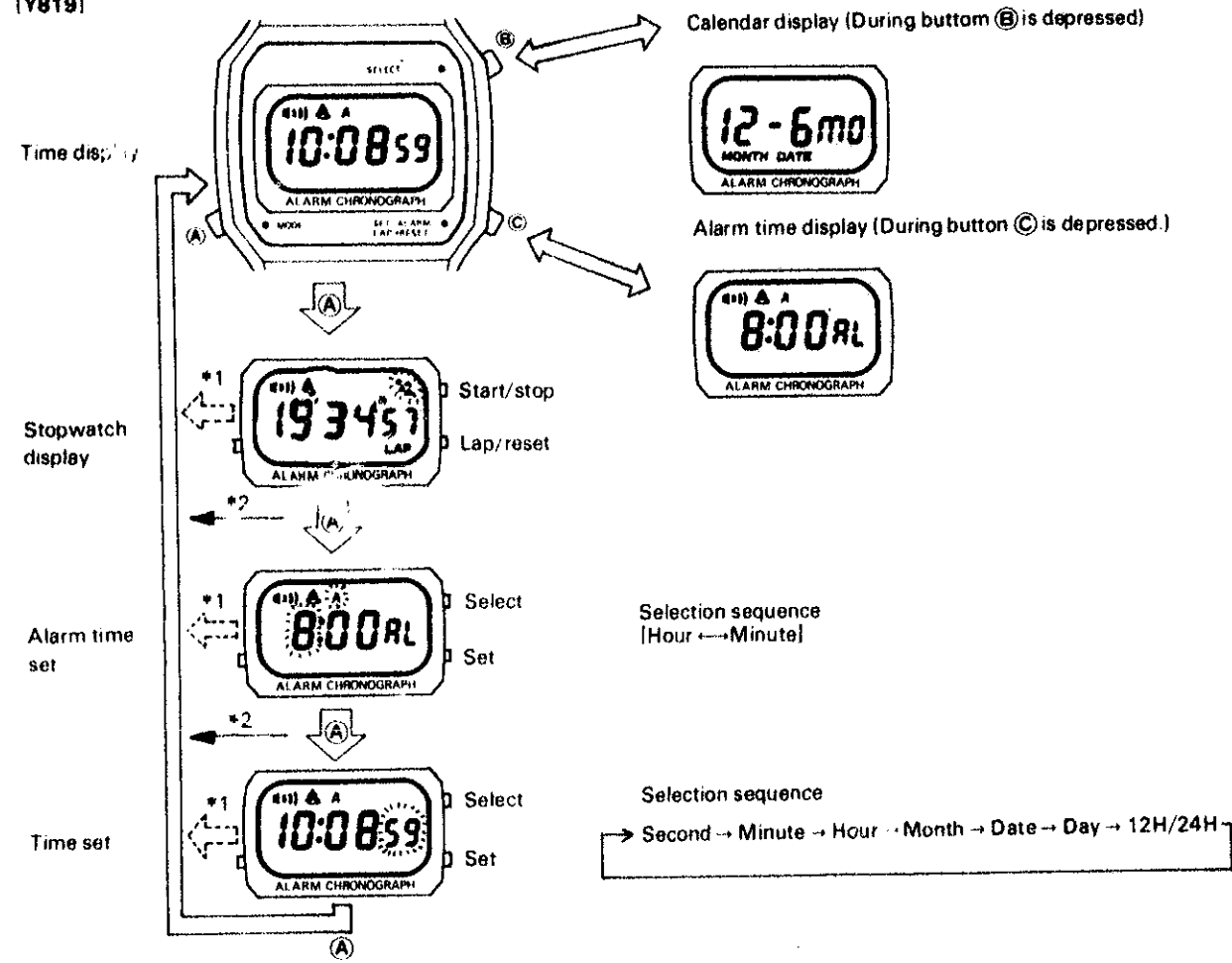

- *1 Automatically returns after 1 ~ 2 minutes.
 - *2 In the display other than time, depressing button (A) after depressing button (B) or (C) will return the watch to time display.
- Common for Cal. Y816

[Y816]

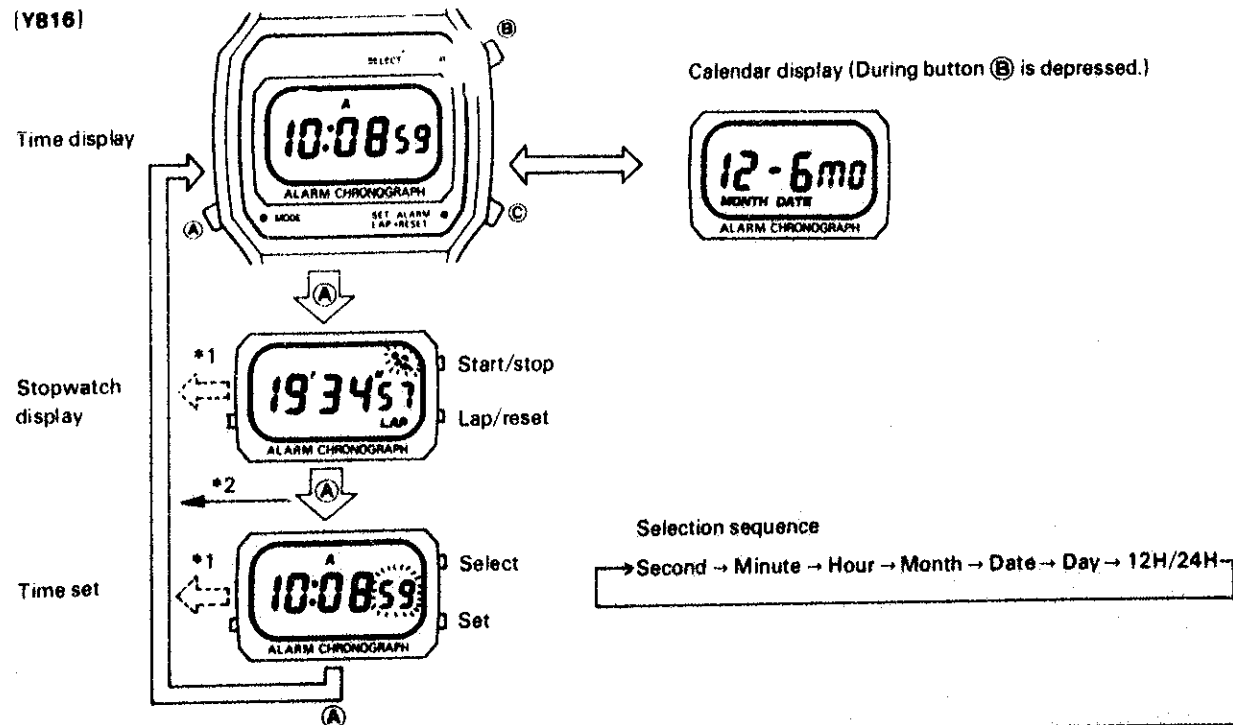

PARTS LIST

CAL. Y816A

Cal. Y816A	
PART NO.	PART NAME
4001 224	Circuit block
* 4228 027	Battery clamp
4270 038	Battery connection (-)
4313 039	Connector
4398 226	Liquid crystal panel frame
4398 227	Battery guard
4510 116	Liquid crystal panel (Silver)
4510 117	Liquid crystal panel (Gold)
4510 118	Liquid crystal panel (Silver, wink animation)
4521 081	Reflecting mirror
MAXELL SR1120SW SEIZAIKEN TR1120SW	Battery

REMARKS:

*Battery clamp for Pulsar watches

4225031 (Pulsar marking)

PARTS LIST

CAL. Y819A

Cal. Y819A	
PART NO.	PART NAME
4001 222	Circuit block
* 4225 026	Battery clamp
4246 016	Speaker lead terminal
4270 038	Battery connection (-)
4313 039	Connector
4398 224	Battery guard
4398 226	Liquid crystal panel frame
4510 116	Liquid crystal panel
4521 081	Reflecting mirror
U.C.C. 391	Battery
MAXELL SR1120W	
TOSHIBA SR1120W	
SEIZAIKEN TR1120W	

REMARKS:

* Battery clamp for Pulsar Watches

*4225033 (Pulsar marking)